

RADIO'S LIVEST MAGAZINE



January
25 Cents
Com. 300

P. 39, K. Voltage, pg 417 and 421

Radio-Craft

HUGO GERNSBACK Editor

Tube chart readings pg 27
pg 401 Class B ampl 46 tubes for more power in the 25's tubes
pg 420 very good info
Pg 398-399 Tubes, the 1000 will give you much more
for class B amp in 1940
440 ohm set to center tap on
475

**How to Build the New
METERLESS
Tube Tester**
See Page 394



**A General-Purpose Meter—Improving S. W. Set Design—P. A. Systems
Resistance-Measurement Servicing—The "58" in Fidelity Control**

NOW ORDER THESE GUARANTEED GENUINE

PHILCO PARTS & PARTS KITS

FOR ALL RADIOS

At Less Than the Cost of Ordinary Parts of Doubtful Manufacture

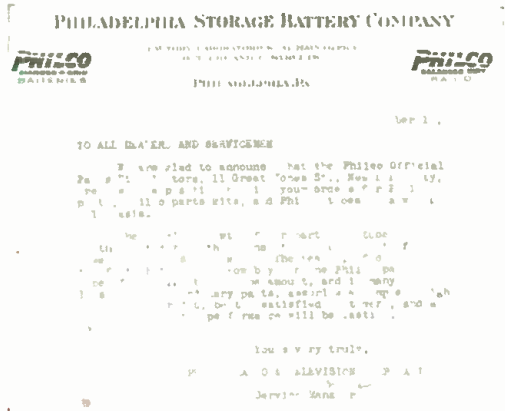

This letter is your guarantee of the unquestionable genuineness of our Philco Parts, including unrivaled Philco Balanced Tubes.



TONE CONTROL KIT
Part Number 7708—Eight standard four point tone controls complete with mounting nuts. Net dealer price \$2.12.

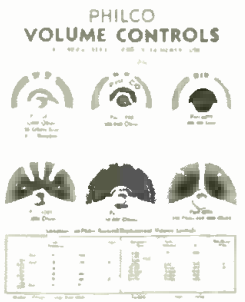

VOLUME CONTROL KIT
Part Number 7538—Complete with six assorted volume controls, mounting nuts and washers. Net dealer price \$3.50.

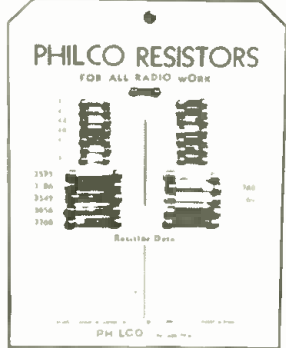

RESISTOR KIT
Part Number 8566-A—Twenty-five Philco resistors, standard R.M.A. color coded, ranging from 1000 ohms to 4 megohms. Net dealer price \$3.67.

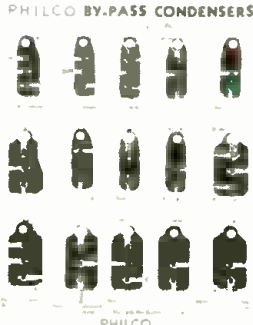

BY-PASS CONDENSER KIT
Part Number 7540—Fifteen by-pass condensers ranging from .01 Mfd. to .18 Mfd. Complete with mounting screws. Net dealer price \$1.77.

Here are the popular Philco Parts Kits which every Serviceman, Dealer, and experimenter needs. . . The same high quality parts used in Philco Radio are now available for service replacements on all receivers.

FILL IN POSTAL AT REAR OF BOOK for catalog showing Lower Prices on Quantity Shipments.
If ordering at the same time, inclose postal in envelope together with cash or money order.

PHILCO BALANCED TUBES

Entire Line, including the NEW HIGH EFFICIENCY TYPE which improve the tone, increase the power, yet consume less current.

Philco Balanced Tubes better the reception of ANY radio. Quick-heating, powerful, and long lasting.

TYPICAL EXAMPLES OF SPECIAL PRICES ON PHILCO BALANCED TUBES . . . Similar discounts on all other numbers.

No.	Reg.	Spec.	No.	Reg.	Spec.
24	1.65	\$0.81	56	1.30	\$0.64
26	.85	.42	57	1.65	.81
27	1.05	.52	58	1.65	.81
45	1.15	.56	80	1.05	.52

ANY PHILCO PART SHIPPED TO YOU PARCEL POST AT THE LOWEST PRICE



SPECIAL PRICES on large tube quantities on application

MICA CONDENSER KIT
Part Number 7452—Ten mica condensers ranging in capacity from .00005 Mfd. to .003 Mfd. Net dealer price \$1.29.

PHILCO OFFICIAL PARTS DISTRIBUTOR

6-8 Great Jones St., New York, N. Y.

LEARN RADIO IN 10 WEEKS!

PAY FOR YOUR TRAINING PAY AFTER YOU GRADUATE

I am making an offer that no other school has dared to do. I'll take you here in my shops and give you this training and you pay your tuition after you have graduated. Two months after you complete my course you make your first payment, and then you have ten months to complete your payments. There are no strings to this offer. I know a lot of honest fellows haven't got a lot of money these days, but still want to prepare themselves for a real job so they won't have to worry about hard times or lay offs.

I've got enough confidence in these fellows and in my training to give them the training they need and pay me back after they have their training.

If you who read this advertisement are really interested in your future here is the chance of a life time. Mail the coupon today and I'll give you all the facts.



A scene in the big, busy Radio Shops at Coyne. Here you see fellows working on real Radios—not reading about them from books or lessons. This is THE way to prepare for the big-money field of Radio!

TELEVISION *and* TALKING PICTURES

Television is already here! Soon there'll be a demand for THOUSANDS of TELEVISION EXPERTS! The man who learns Television now can have a great future in this great new field. Get in on the ground-floor of this amazing new Radio development! Come to COYNE and learn Television on the very latest, newest Television equipment. Talking Picture and Public Address Systems offer opportunities to the Trained Radio Man. Here is a great new Radio field just beginning to grow! Prepare NOW for these wonderful opportunities! Learn Radio Sound Work at Coyne on actual Talking Picture and Sound Reproduction equipment.

PREPARE NOW and be ready for Radio's many opportunities

Forget pay-cuts—lay-offs—unemployment! Don't be tied down to an untrained man's future. You NEED TRAINING IN A FAST-GROWING MONEY-MAKING TRADE. Here's your chance of a lifetime to get it! Hundreds of opportunities now open in Radio. My sensational offer, explained below, makes it possible for you to START AT ONCE!

The right way to learn Radio is the Coyne way—not by books, but by actual, practical work on actual Radio, Television and Sound equipment. Here at Coyne you'll service and operate scores of modern Radio receivers, huge Broadcasting equipment, late type Television apparatus, Talking Picture machines, Code transmitters and receivers, etc. In 10 weeks you can step into a REAL JOB, leading to a salary of \$50 a week and UP!

ALL PRACTICAL WORK At COYNE in Chicago

ALL ACTUAL, PRACTICAL WORK. You build radio sets, install and service them. You actually operate great Broadcasting equipment. You construct Television Receiving Sets and actually transmit your own Television programs over our modern Television equipment. You work on real Talking Picture

machines and Sound equipment. You learn Wireless Operating on actual Code Practice apparatus. We don't waste time on useless theory. We give you the practical training you'll need—in 10 short, pleasant weeks.

MANY EARN WHILE LEARNING

You get Free Employment Service for Life. And don't let lack of money stop you. Many of our students make all or a good part of their living expenses while going to school and if you should need this help just write to me. Coyne is 33 years old. Coyne Training is tested—proven beyond all doubt. You can find out everything absolutely free. Just mail coupon for my big free book!

**H. C. LEWIS, Pres. RADIO DIVISION Founded 1999
COYNE ELECTRICAL SCHOOL
500 S. Paulina St., Dept. 13-8H, Chicago, Ill.**

Mail Coupon Today for All the Facts

**H. C. LEWIS, President
Radio Division, Coyne Electrical School
500 S. Paulina St., Dept. 13-8H, Chicago, Ill.**

Dear Mr. Lewis: Send me your big FREE Book; details of your FREE Employment Service; and tell me all about your special offer of allowing me to pay for training on easy monthly terms after graduation.

Name.....
Address.....
City..... State.....



HUGO GERNSBACK, Editor-in-Chief

LOUIS MARTIN
Associate Editor

R. D. WASHBURNE
Technical Editor

CONTENTS OF THE JANUARY, 1933, ISSUE

VOLUME IV

NUMBER 7

EDITORIAL:

Profits in the New Tubes Hugo Gernsback 393

NEW DEVELOPMENTS IN RADIO:

How to Build this \$5 Meterless Tube Tester.....S. D. Prensky 394
The Latest Radio Equipment 396
New Tube Announcements.....Louis Martin 398

SERVICE MEN'S DEPARTMENT:

RADIO-CRAFT'S List of Trade Names and Model Numbers ... 404
How to Make a General-Purpose Test Meter.....Paul Shallcross 406
Constructing Adapters for Test Equipment.....F. L. Sprayberry 408
Servicing Receivers by the Resistance Method.....H. G. Cisin 410
Reducing Man-Made Static.....Glenn H. Browning 412
Operating Notes..... 413
Short Cuts in Radio Servicing..... 414
Servicing With An Oscillator.....M. D. Yanasko 415

RADIO SERVICE DATA SHEETS:

No. 81: Philco Models 80 and 37 416
No. 82: Stewart-Warner Models 50, 51, and 58..... 417
The Service Man's Forum..... 418

TECHNICAL RADIO TOPICS:

A 1-Tube, Portable, Universal-Current Set
R. D. Washburne and F. R. Harris 400
How To Build This 13-Watt, Class B Amplifier
L. J. Littman 401
Using the V.T. Voltmeter.....Beryl B. Bryant 402
Making Money with P.A. Amplifiers.....Hubert L. Short 403
RADIO-CRAFT Kinks..... 419
Improving S.W. Reception.....R. W. Tanner 420
The Radio Craftsman's Page 422
Information Bureau..... 424
Blowtorching Tubes to Life Glenn Ellsworth 448A
Noise Reducing Antenna SystemsL. W. Van Slyck 448B

IN OUR NEXT FEW ISSUES:

THE "TRAUTONIUM," A NEW MUSICAL RADIO INSTRUMENT.
Complete details for the construction of this electrical musical instrument of exceptional usefulness will be described in this magazine for the first time in this country. This instrument may be connected to any radio set and is capable of imitating any musical instrument from a bass drum to a piccolo.

HOW TO ADVERTISE. This is an unusual article on radio advertising for the Service Man. It is not the ordinary array of stereotyped material that finds its way into radio literature, but represents the findings of a man whose job it is to know what advertising is best for the Service Man.

A LONG-WAVE TUNER CHASSIS. Complete constructional data of a tuner chassis for the longer wave lengths—from 550 to 2,000 meters—which can pick up foreign broadcasts from this country. This receiver has actually been used for several months and is not merely speculative material—it's practical.

RADIO-CRAFT is published monthly, on the fifth of the month preceding that of date; its subscription price is \$2.50 per year. (In Canada and foreign countries, \$3.00 a year to cover additional postage.) Entered at the post office at Mt. Morris, Ill., as second-class matter under the act of March 3, 1879. Trademark and copyright by permission of Gernsback Publications, Inc., 98 Park Place, N. Y. C. Text and illustrations of this magazine are copyright and must not be reproduced without permission of the copyright owners. We are also agents for WONDER STORIES and WONDER STORIES QUARTERLY. Subscription to these magazines may be taken in combination with RADIO-CRAFT at reduced Club rates. Write for information.

Copyright 1932. GERNSBACK PUBLICATIONS, INC.

HUGO GERNSBACK, President J. M. HERZBERG, Vice-President
S. GERNSBACK, Treasurer I. S. MANHEIMER, Secretary

Published by TECHNI-CRAFT PUBLISHING CORPORATION. Publication office: 404 N. Wesley Ave., Mount Morris, Illinois. Editorial and Advertising Office: 96-98 Park Place, New York City. Chicago Advertising Office: 737 North Michigan Avenue, Chicago, Ill. Western Advertising Office: 220 No. Catalina St., Los Angeles, Calif. L. F. McClure, Chicago Advertising Representative. Loyd B. Chappell, Western Advertising Representative.

London Agent: Hachette & Cie., 3 La Belle Sauvage, Ludgate Hill, E.C. 4
Paris Agent: Hachette & Cie., 111 Rue Reaumur
Australian Agent: McGill's Agency
179 Elizabeth St., Melbourne

It's What's **BEHIND** the

SCOTT ALL-WAVE
15-550 *Deluxe* **METER**

that makes it
THE WORLD'S FINEST RADIO RECEIVER

This special SCOTT-designed precision instrument, found in no other laboratory, matches oscillator coils with the antenna with which they are used. So delicate that each coil is matched to its antenna within $\frac{1}{2}$ of a single turn of wire.

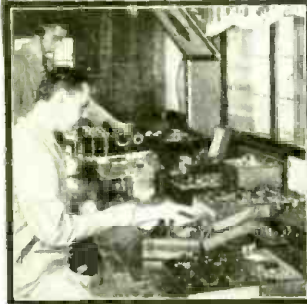

The SCOTT Research Laboratory is constantly engaged in testing and experimenting to discover new ways and means of assuring SCOTT ALL-WAVE DELUXE owners better reception, finer tone and a higher degree of satisfaction with their sets.

'Round-the-world reception guarantee . . . unparalleled tone fidelity . . . super-selectivity . . . true single dial control on all reception between 15 and 550 meters . . . no plug-in or tapped coils . . . the whole radio-wise world is talking of the sensational performance of this new SCOTT ALL-WAVE DELUXE!

Perhaps you've wondered . . . perhaps you, too, have questioned *how* such performance could be secured.

To know, you must look behind the scenes. You must see the infinite care, the accuracy, the micrometer-measured exactness, with which specially trained craftsmen build these receivers in the way that all fine things are built . . . by hand!

Still farther back you'll find super-careful selection of every part that goes into every SCOTT receiver. Tested again and again . . . coils, condensers, transformers—every single part must meet the most rigid specifications by trial on delicate instruments infinitely more revealing than any human judgment.

No mass-production methods here—no slap-bang assembly of "good enough" parts. Every step in the construction of a Scott receiver is one of care and deliberation, taken by an expert.

No wonder the completed receiver is a "world-beater." No wonder more than 19,000 logs of foreign reception on Scott receivers have been sent to us since January 1st, 1932. No wonder Scott receivers have held world's record distance reception honors for more than six years. The whole story of SCOTT laboratory technique in radio receiver construction is a fascinating one. You should have it, to know how fine things are made. And the more you learn, the more you will marvel that such quality can be had at such moderate cost. Send for the whole story NOW!

Get our newly published brochures, "The Creation of a Masterpiece," and "PROOF of Consistent Foreign Reception." They will tell you what *real* radio performance is . . . and PROVE that you get it from a SCOTT ALL-WAVE DELUXE.

E. H. SCOTT RADIO LABORATORIES, INC.
4450 Ravenswood Ave., Dept. C-13, Chicago, Illinois

SEND THIS COUPON FOR PROOF

Within a carefully shielded room, from which all outside disturbances are excluded, SCOTT receivers are tested on signals sent within the laboratory from very latest type GR standard frequency generator and a GR audio oscillator.

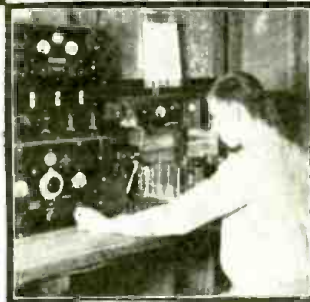

Here is how resistors in SCOTT receivers are tested, to assure fine tone, fine tuning and super sensitivity. The delicacy of these testing instruments detects variations of $\frac{1}{2}$ of 1% from proper ratings. The SCOTT standard for acceptance demands perfection.

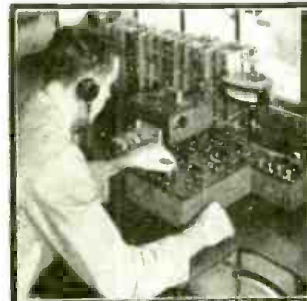

In this electric oven the "climate" is baked out of SCOTT transformers. After every iota of moisture is baked out, the parts are treated so that they will always deliver perfect service in any climate from that of the Arctic to the humid heat of the Tropics.

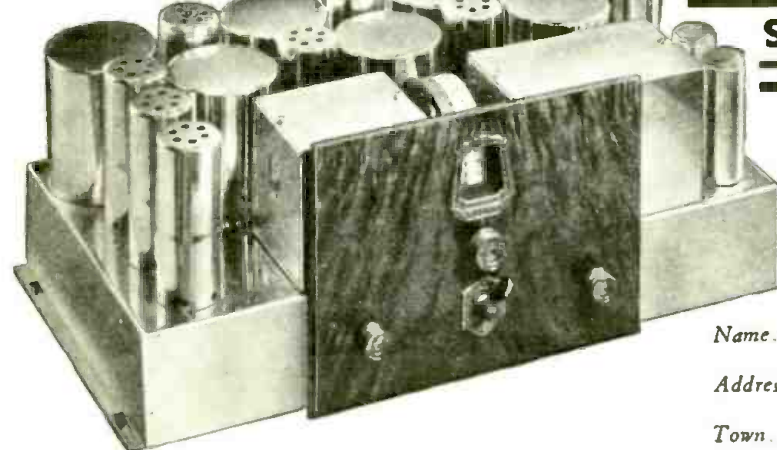

E. H. SCOTT RADIO LABORATORIES, INC.,
4450 Ravenswood Ave., Dept. C-13, Chicago, Ill.

Send me your two new brochures that tell how and why SCOTT ALL-WAVE DELUXE Receivers out-perform all others. This is not to obligate me in any respect.

Name.....

Address.....

Town..... State.....



More Money

I show beginners how
-- experienced service men

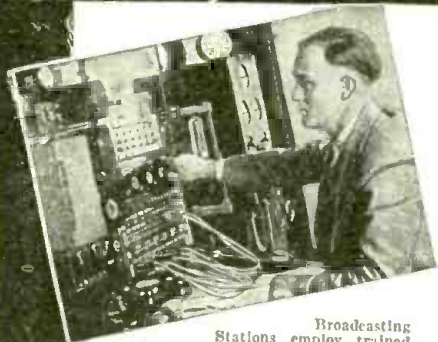

Broadcasting Stations employ trained men for jobs paying up to \$5,000 a year.



Television—the coming field of many great opportunities—is covered by my course.



Spare time set servicing pays many N.R.I. men \$200 to \$1,000 a year. Full time men make as much as \$50, \$65, and \$75 a week.



Talking Movies—an invention made possible by Radio—employs many well trained Radio men for jobs paying as much as \$75 to \$200 a week.

My book, "Rich Rewards in Radio," gives you full information on the opportunities in Radio and explains how I train beginners at home to become Radio Experts and experienced service men for better Radio jobs—better pay. It's free. Clip and mail the coupon NOW. Radio's amazing growth has made hundreds of fine jobs which pay \$50, \$60, \$75, and as much as \$100 a week. Many of these jobs lead to salaries as high as \$125 and \$150 a week.

Radio—the Field with a Future

Once or twice in a man's lifetime a new business is started in this country. You have seen how the men and young men who got into the automobile, motion picture, and other industries when they were started had the first chance at the big jobs—the \$5,000, \$10,000, and \$15,000 a year jobs. Radio offers the same chance that made men rich in those businesses. It has already made many men independent and will make many more wealthy in the future. You will be kicking yourself if you pass up this once-in-a-lifetime opportunity for financial independence.

Many Radio Experts make \$50 to \$100 a week

In the short space of a few years, 300,000 Radio jobs have been created, and thousands more will be made by its future development. Men with the right training—the kind of training I will give you in the N.R.I. Course—have stepped into Radio at 2 and 3 times their former salaries. Experienced service men as well as beginners praise N.R.I. training for what it has done for them.

Many make \$5, \$10, \$15 a week extra in spare time almost at once

My Course is world-famous as the one "that pays for itself." The day you enroll I send you material, which you should master quickly, for doing 28 Radio jobs common in most every neighborhood. Throughout your Course I will show you how to do other repair and service jobs on the side for extra money. I will not only show you how to do the jobs, but how to get them. I'll give you the plans and ideas that have made \$200 to \$1,000 a year for N.R.I. men in their spare time. G. W. Page, 110 Raleigh Apts., Nashville, Tenn., wrote me: "I made \$935 in my spare time while taking your Course." My book, "Rich Rewards in Radio," gives many letters from students who earned four, five, and six times their tuition fee before they graduated.

Get ready for jobs like these

Broadcasting stations use engineers, operators, station managers and pay up to \$5,000 a year. Radio manufacturers



Police Departments are finding Radio a great aid in their work. Many good jobs have been made in this new field.

Sample Lesson FREE

I'll send you a Free Lesson to prove that my Radio Course is easy, practical. That's how confident I am that I can train YOU at home in your spare time to become a Radio expert. Only my students could have this book in the past. I KNOW that when you see it, read it, examine it you will be delighted with its clear, simple way of teaching Radio. I KNOW—because I have ALREADY trained thousands of men. Many of them with not even a grammar school education, and no Radio or electrical experience, have become Radio experts and earn two or three times their former pay. Mail the coupon now.



Some of the Jobs N. R. I. Trains Men For

- Broadcast Engineer
- Maintenance Man in Broadcasting Station
- Installation Engineer of Broadcast Apparatus
- Operator in Broadcast Station
- Aircraft Radio Operator
- Operator of Airway Beacons
- Service Man on Sound Picture Apparatus
- Operator of Sound Picture Apparatus
- Ship Operator
- Service Man on Public Address Systems
- Installation Engineer on Public Address Systems
- Sales Manager for Retail Stores
- Service Manager for Retail Stores
- Auto Radio Installation and Service Man
- Television Broadcast Operator
- Set Servicing Expert

Act! MAIL COUPON Today - - - Get The Facts About

for You in Radio

**to get into Radio quickly
how to get better jobs-better pay**

Here's Proof



\$400 Each Month

"I spent fifteen years as travelling salesman and was making good money, but could see the opportunities in Radio. Believe me, I am not sorry, for I have made more money than ever before. I have made more than \$400 each month and it really was your course that brought me to this. I can't say too much for your school." J. G. Dahlstead, Radio Station KYA, San Francisco, Cal.



Radio Service Man Doubles Salary

"I spent 15 years building and repairing Radios, but felt I could refresh my memory and learn about developments I had overlooked. Upon completion, I was appointed Service Manager of Parks & Hull, and was immediately repaid for the cost and time spent in study. I give the N.R.I. full credit for my success in the Radio field—it immediately increased my earnings 100%." J. E. McLaurine, 1511 Guilford Ave., Baltimore, Md.



From \$10 to \$50 a week in spare time

"Besides being employed by the Power & Light Company to locate Radio interference in this district, which is a very good position, I have a service business of my own that nets me from \$10 to \$50 a week in spare time. I owe all my success to the National Radio Institute, as I was only a common factory worker before taking the course." H. L. Penie, 812 W. High Street, Piqua, Ohio.

employ testers, inspectors, foremen, engineers, service men, buyers, and managers for jobs paying up to \$6,000 a year. Radio dealers and jobbers (there are over 35,000) employ service men, salesmen, buyers, managers and pay up to \$100 a week. Radio operators on ships enjoy life, see the world, with board and lodging free, and get good pay besides. Talking pictures pay as much as \$75 to \$200 a week to men with Radio training. There are hundreds of opportunities for you to have a spare time or full time Radio business of your own—to be your own boss. I'll show you how to start your own business with practically no capital—how to do it on money made in spare time while learning. My book tells you of other opportunities. Be sure to get it at once. Just clip and mail the coupon.

You can learn at home in your spare time to be a Radio Expert

Hold your job. There is no need for you to leave home. I will train you quickly and inexpensively during your spare time. You don't have to be a high school or college graduate. My Course is written in a clear, interesting style that most anyone can grasp. I give you practical experience under my 50-50 method of training—one-half from lesson books and one-half from practical experiments with equipment given without extra charge. This unique and unequalled method has been called one of the greatest developments in correspondence Radio training. N.R.I. pioneered and developed it. It makes learning at home easy, fascinating, practical.

Learn the secrets of Short Wave, Television, Talking Pictures, Set Servicing, Broadcastitg

I'll give you more training than you need simply to get a job—I'll give you your choice, and not charge you extra either, of my Advanced Courses so that you may SPECIALIZE in these subjects—(1) Television, (2) Set Servicing and Merchandising, (3) Sound Pictures and Public Address Systems, (4) Broadcasting, Commercial and Ship Radio Stations, (5) Aircraft Radio. Advanced specialized training like this gives you a decided advantage.

Your Money Back if you are Not Satisfied

I will give you an agreement in writing, legal and binding upon this Institute, to refund every penny of your money upon completing my Course if you are not satisfied with my Lessons and Instruction Service. The resources of the National Radio Institute, Pioneer and World's largest Home-Study Radio School, stand behind this agreement.

Find out what Radio offers you Get my book AT ONCE

One copy of my valuable 64-page book, "Rich Rewards in Radio," is free to any resident of the U. S. and Canada over 15 years old. It has started hundreds of men and young men on the road to better jobs and a bright future. It has shown hundreds of men who were in blind alley jobs, how to get into easier, more fascinating, better paying work. It tells you what my graduates are doing and making, where the good jobs are in Radio, what they pay, how you can quickly and easily fit yourself to be a Radio Expert. The Coupon will bring you a copy free. Send it at once. Your request does not obligate you in any way. ACT NOW.

J. E. SMITH, President
Dept. 3AX, National Radio Institute
Washington, D. C.

SPECIAL Radio Equipment for Broad Practical Experience Given Without Extra Charge

My course is not all theory. I'll show you how to use my special Radio Equipment for conducting experiments and building circuits which illustrate important principles used in such well-known sets as Westinghouse, General Electric, Philco, R.C.A., Victor, Majestic, and others. You work out with your own hands many of the things you read in our lesson books. This 50-50 method of training makes learning at home easy, interesting, fascinating, intensely practical. You learn how sets work, why they work, how to make them work when they are out of order. Training like this shows up in your pay envelope—when you graduate you have had training and experience—you're not simply looking for a job where you can get experience.

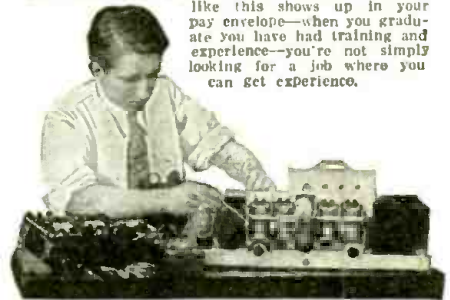

With N.R.I. equipment you learn to build and thoroughly understand set testing equipment—you can use N.R.I. equipment in your spare time service work for extra money.

I have doubled and tripled the salaries of many. Find out about this tested way to **BIGGER PAY**



FILL OUT AND MAIL THIS COUPON TODAY

Mr. J. E. SMITH, President
National Radio Institute, Dept. 3AX,
Washington, D. C.

Dear Mr. Smith: I want to take advantage of your Special Offer. Send me "A Bird's Eye View of Radio" and your book, "Rich Rewards in Radio," which points out the opportunities for spare time and full time jobs in Radio and your famous 50-50 method of training men to become Radio experts through home study. I understand this request places no under no obligation.

Name.....

Address.....

City..... State.....

The Famous Course That Pays For Itself

On this page are listed manufacturers' catalogs and booklets, chosen because they are of interest to readers of RADIO-CRAFT. You can obtain copies FREE by using the coupon below.

5. CLAROSTAT CONTROL HANDBOOK. A large 32-page book containing detailed specifications of volume controls, attenuators, constant-impedance controls, phonograph pickup faders, tone controls, line ballasts, rheostats, potentiometers and fixed resistors of various kinds, together with valuable circuit-design data. Contains many diagrams and charts, and a guide of replacement volume and tone controls for many commercial receivers. *Clarostat Manufacturing Company, Inc.*

6. MEASURING RESISTANCE BY THE DEFLECTION METHOD. The conventional method for the measurement of resistance involves the use of the Wheatstone bridge, a costly piece of apparatus. However, there are other methods which provide a fair degree of accuracy, enough for all practical purposes. The least expensive is the deflection method, which makes use of popularly priced milliameters and fixed resistances. This bulletin describes the method completely, and should be very useful to Service Men and experimenters with limited meter equipment. *Shalleross Manufacturing Company.*

8. ELECTRAD PRODUCTS. Descriptions of the full line of Electrad volume controls, voltage dividers, vitreous resistors, Truvolt adjustable resistors, amplifiers and other devices for radio and electrical applications. Among other diagrams, it includes twenty-four circuits showing the placement of volume controls in different types of broadcast receivers. *Electrad, Inc.*

11. SUPREME INSTRUMENTS. Contains lengthy descriptions of the Supreme service instruments, including the AAA1 Diakometer, which is five instruments in one, the model 90 analyzer, the model 40 tube tester and the models 60 and 70 oscillators. Interesting to the Service Man because it tells how his work is facilitated by ingeniously-designed test equipment that indicates the condition of an entire set in a few minutes. New test apparatus to take care of the new tubes is also described. *Supreme Instrument Corporation.*

14. STANDARD RESISTOR COLOR CODE. This handy little card, measuring three by five inches, should be in every Service Man's kit. It illustrates and explains the standard R.M.A. method of marking fixed resistances with different combinations of colors to indicate the resistance value in ohms. It will save a lot of confusion in the field, as most resistors are now marked only by color, and do not bear figures at all. *Lynch Manufacturing Company, Inc.*

19. A BAPTISM OF FIRE. Centralab fixed resistors are made by forcing a carefully calibrated resistance material through a plastic ceramic material, and then baking both under terrific heat. This booklet describes the manufacturing process in detail, and lists the advantages claimed for fixed resistors of this type. It is interestingly written and illustrated, and makes good reading. *Central Radio Laboratories, Inc.*

21. READRITE RADIO INSTRUMENTS. This sixteen-page pamphlet contains some valuable hints on the testing of electrolytic condensers, as well as descriptions of the full line of popular-priced Readrite instruments. Worth having. *Readrite Meter Works.*

22. HOW TO TEST PENTODES. This is a reprint of an article of the same name that appeared in the September, 1931, number of RADIO-CRAFT, accompanied by descriptive matter on the adapters specified for the purpose. If you missed the original article study the reprint; it contains much useful data for owners of testers or analyzers not already equipped to test pentodes. *Alden Manufacturing Company.*

25. AEROVOX 1932 CONDENSER AND RESISTOR MANUAL AND CATALOG. This 48-page booklet is worth having and saving. In addition to very complete specifications on the full line of Aerovox paper, mica and electrolytic condensers, and vitreous enamel, carbon and wire-bound resistors, it contains a great deal of information and data on condensers and resistors in general which the Service Man and experimenter will be able to apply to his everyday problems. *Aerovox Wireless Corporation.*

27. DUBILIER CONDENSERS. The name Dubilier being synonymous with condensers in the minds of many people, the latest catalog of Dubilier condensers is sure to be of interest to all classes of radio users. This 16-page booklet describes the entire line of receiving condensers and tells something of the historical background of the company. The special service kit and replacement units are recommended to the attention of Service Men. Included with the catalog is an instructive technical article dealing with electrolytic condensers. *Dubilier Condenser Corporation.*

28. HAMMARLUND PRECISION PRODUCTS. Midget variable condensers and their numerous applications in short-wave and broadcast receivers are discussed in a folder accompanying the complete catalog of Hammarlund variable condensers and coils. Some excellent circuit kinks are given. The catalog contains dimensional drawings of the popular Hammarlund midgets which may be of assistance to constructors designing small receivers. *Hammarlund Manufacturing Company, Inc.*

55. PHILCO PARTS CATALOG. This new catalog will undoubtedly be of great help to all radio Service Men because it contains the only official, complete list of the more common replacement parts used in every Philco receiver from the very beginning of the company to the present time. The manufacturers are anxious to cooperate with Service Men and offer this catalog to all who want it. *Philco Radio & Television Corp.*

63. THE AKAFORMER. The Akaformer, described in this folder, is a coupling device that hooks right on to the aerial wire, and connects to the set through a shielded down lead. The combination tends to reduce noise in the set picked up by the usual lead in, which, running along the side of the building, is more readily affected by elevator motors, vacuum cleaners, dentists' drills and other electrical machinery than the flat top section of the aerial proper. The device is inexpensive and is easily installed, and is thereby a very profitable item for Service Men located in districts where artificial noise is very troublesome. *Any, Aceves & King, Inc.*

64. SYLVANIA RADIO TUBES. So many new tubes have appeared during the past several months that tube charts printed as recently as the Spring are incomplete and therefore of little value for reference purposes. Readers desiring new and complete charts for their shop will find the new Sylvania chart very desirable. It measures 11 by 17 inches when unfolded and shows bottom views of the tube bases in addition to full average characteristics of old tubes dating back to the 199 and 200A and all the new tubes including the latest 6.3 and 2.5 volt types. Special mention is made of the 56, 57, 58, 46, and 82 tubes; complete data are also given on the 38, 41, 69, 42 and 44. *Hygrade Sylvania Corporation.*

66. WHOLESALE RADIO SERVICE CATALOG. The 1932 Spring and Summer Radio Catalog of the Wholesale Radio Service Company is the kind of catalog the radio Service Man and experimenter will carry around with him all the time in his back pocket. Measuring 7 by 10 1/4 inches and containing 100 pages, it is one of the most complete catalogs we have ever seen. It includes everything from soldering lugs to all-wave combinations, and is of particular value to the Service Man because of its handy lists of replacement parts for standard receivers. *Wholesale Radio Service Company, Inc.*

77. SAMSON MICROPHONES AND ACCESSORIES. The well-known line of Samson "PAM" amplifiers is now being supplemented by a series of high quality microphones and accessories, which are described in a bulletin which gives their technical characteristics. The first seven "mikes" are of the double-carbon-button type. Four of these are intended for suspension in the familiar ring stand, two are of the hand type, and the last resembles an ordinary desk telephone. The second group comprises three dynamic microphones, which use the same unit in different forms of mounting. The third and last group is a pair of condenser "mikes" designed for broadcasting purposes. All these microphones are of interest to public address and broadcasting specialists. *Samson Electric Company.*

80. FLECHTHEIM CONDENSERS. A wide variety of fixed condensers, ranging from tiny midgets, the size of postage stamps, to heavy transmitting units a foot high, are described and illustrated in the latest Flechtheim catalog. This is very useful for reference in design and service work, as it gives the mechanical dimensions and electrical characteristics of all models in minute detail. *A. M. Flechtheim & Co.*

81. I. R. C. RESISTOR CATALOG. This sixteen-page catalog describes a very complete line of fixed resistors for radio purposes. It includes full performance characteristics, so that a Service Man or an experimenter with a particular requirement in mind can select exactly the right unit for his purpose. A section in the back contains valuable data on the conversion of milliameters into ohmmeters and voltmeters, and on the extension of voltmeter and ammeter ranges. This catalog is well worth saving. *International Resistance Company.*

82. MILES BULLETINS. Bulletin J features midget and lapel microphones, home broadcast units and portable group-address amplifiers. The use of a lapel "mike" for faking in announcements on the family radio receiver is suggested as a home entertainment stunt. Bulletin M deals with simple private communication systems, for which there are big possibilities in offices, factories, homes etc. *Miles Reproducer Co.*

84. POSTAL TUBE CHART. Service Men and others who have been confused by the recent avalanche of new tubes will welcome this large chart, which shows the pin arrangement and socket connections of the latest types. It is very handy for reference purposes in the shop or out in the field. *Postal Radio Corp.*

85. CONTINENTAL SUPPRESSORS. This special bulletin describes suppressor resistors and condensers for automobile ignition systems. Some valuable suggestions for installing the devices and for eliminating interference are given. The method of using suppressors on a typical ignition system is illustrated. *Continental Carbon Inc.*

89. MICROPHONES. A complete line of microphones and accessories for amateur, public address and broadcast station use is described and illustrated in a handy four-page pamphlet. The "mikes" range from small hand units to large condenser models containing two stages of amplification. *Sound Engineering Corporation.*

90. THE DECIBEL. The theory, derivation and use of the decibel, the universally employed unit of electro-acoustics, are simply explained in an excellent folder issued for the benefit of workers in the sound field. If you have found the term confusing you will benefit greatly by reading this clear treatise. *Electrical Sound Institute, Inc.*

RADIO-CRAFT 5-90
Readers Bureau
96-98 Park Place, New York, N. Y.

Please send me free of charge the following booklets indicated by numbers in the published list above:

No.

Name

Address

City State.....

(Please check the following)

I am

(1) Service Man (2) Experimenter

(3) Dealer (4) Jobber

(5) Radio Engineer

(6) Licensed Amateur

(7) Professional or Amateur Set

Builder

This coupon will not be honored unless you

check off your classification above.

Super Power

GUARANTEES

*To You Every Bit of Performance Possible
Under Prevailing Atmospheric Conditions*

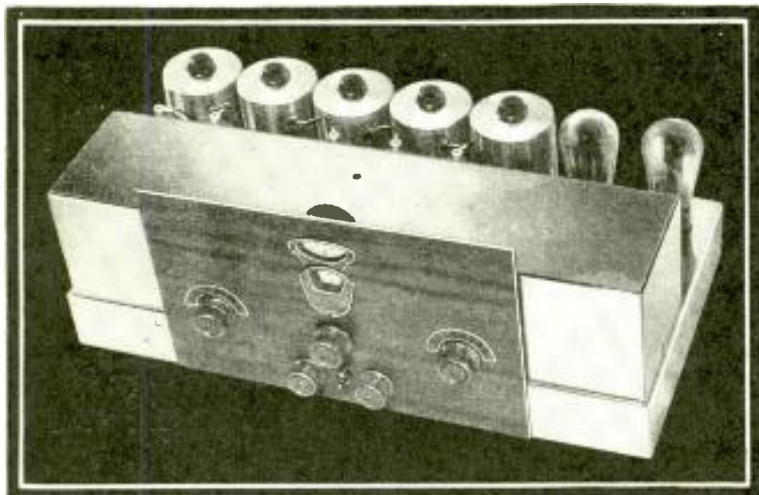

Lincoln DeLuxe *All Wave Superheterodyne*

15 TO 550 METERS

With undistorted amplification made possible thru Lincoln's foresight in development of new triple push pull detector and audio system.

Automatic Volume Control

Signal Indicator

Four High Gain I. F. Stages

BRING THE WORLD RIGHT INTO YOUR HOME

with proven equipment used by the MacMillan Polar Expedition, Commercial Experts and Individuals the world over.

SUPER POWER of the New Twelve-Tube Lincoln DeLuxe SW-33, coupled with the new Lincoln developments, guarantees to you real radio reception of unlimited distance.

If you have never tuned the new Lincoln you have missed the treat of your life.

Just tune to a European station which ordinarily fades completely out at times, and note how the Lincoln new automatic volume control holds the signal at a perfect level.

Watch the signal indicator register the weakest signal, and then tune to the exact center of the carrier wave with absolute precision.

When you wish to tune late at night, open up the sensitivity control wide, and reduce volume control to whisper.

Throw in the 53 to 1 ratio on the dial for ease in tuning high frequencies.

Open up the volume control to the limit and shake the floor with the tremendous amplification, without distortion.

Listen to the heavy bass vibratory notes produced by the use of the push-pull detector followed by two stages of push-pull audio and reproduced in the finest auditorium type speaker we can procure.

Note the high sensitivity provided by four tuned stages of intermediate amplification—just tune in a foreign station—you will want the volume control opened only a few degrees.

Just note what a recent Lincoln owner in Java (a country with extremely bad weather conditions, and mineral deposits, making high noise interference) says about the new Lincoln: "Foreign stations come in very loudly. Paris, Rome, Zeesen, Konig-

swusterhausen, Chelmsford and a score of other European stations come in clearly; Sydney, Queensland and Melbourne from Australia can be received with great volume; JIAA from Japan is consistently heard, while Pittsburgh and Schenectady have been received. Also on the broadcast band daily reception can be had from several European stations, Japan, Manila and China. I have heard of no other set that can equal your Lincoln."

Owners of the first Lincoln models are still proud of their performance.

BATTERY RECEIVER uses eleven (11) two-volt tubes, and can be used in connection with the Air Cell or storage batteries.

Mail the coupon for Laboratory information and price. New York City territory write Valentine G. Hush, Division Drive, Dobbs Ferry, N. Y.

LINCOLN
DeLuxe Receivers

LINCOLN RADIO CORPORATION

Dept. RC-1, 329 S. Wood St., Chicago, Ill.

Please send information on A.C. D.C. receivers.

Name

Address

City State

Print name and address plainly

KEEP STEP WITH RADIO PROGRESS!

RADIO is one of the real marvels of this modern age. Its development has been phenomenal. It is growing, changing, evolving new principles which require constant study. The demand is for technically trained men—men who keep pace with the unfolding revelations of this mighty and promising industry.

The International Correspondence Schools Course in Radio, prepared and constantly supplemented by outstanding authorities in the field, is specifically designed to meet the requirements of the radio industry for technically trained radio men. The manufacturer, the distributor, the dealer, Communication and Steamship Companies, the U. S. Government, all insist upon up-to-date, expert training. Recognized for its completeness and practicability, an I.C.S. Radio Course provides this training.

Authorities responsible for the preparation of the I.C.S. Radio Course include: H. H. Beverage, Radio Corporation of America; George C. Crom, American Transformer Company; Keith Henney, author of "Principles of Radio"; E. V. Amy, consulting radio engineer, formerly with R. C. A.; H. F. Dart, authority on radio tubes; Julius C. Aceves, consulting radio engineer, formerly of Columbia University, and others.

The I. C. S. Radio Course is complete, from the foundational principles of radio to the most advanced stages, thoroughly and scientifically covering every department of this vast industry. It is a modern education in radio, a valuable guide of advancement for men engaged professionally in the radio business. It also outlines the principles and possibilities of television.

Mark and mail the coupon. We will send you all details. This act may be the real beginning of your career in radio!

INTERNATIONAL CORRESPONDENCE SCHOOLS, Box 6677
Scranton, Penna.

Without cost or obligation, please tell me all about the
NEW RADIO COURSE

Name _____

Street Address _____

City _____ State _____

If you reside in Canada, send this coupon to the International Correspondence Schools Canadian,
Ltd., Montreal, Canada





"Takes the Resistance Out of Radio"

PROFITS IN THE NEW TUBES

An Editorial by HUGO GERNSBACK

THE Radio Service Man has, right now, the greatest opportunity to get an additional income with little trouble, and with a minimum of sales effort. The radio tube manufacturers have been exceedingly good to the Radio Servicing trade. They have all worked during 1932 to bring out such a profusion of tubes as has never been put on the market in a similar span of time. The wide-awake Service Man is now in a position to take advantage of this situation, and if he does not cash in on it, he has only himself to blame.

All he needs to do is to carry with him a few of the new tubes when he makes a call. Nine times out of ten, the radio set owner is still using the old tubes, and it is not a difficult trick to make a sale almost immediately. No high pressure methods, and very little sales talk is required. All you have to do is to find out the following:

What stations does the set owner receive poorly now? Is the volume satisfactory? Are distant stations received with good volume? Is the tone of the set as good as it should be? Do distant and nearby distant stations fade badly? These are just a few of many questions that may be asked, and almost immediately rectified.

All the Service Man needs to do is to take the old tubes from the set and replace them with the new and modern tubes. *Let the set owner be the judge.* You will find that it is not at all difficult to make a sale, because nine times out of ten the new tubes with their greater efficiency will make the sale for you and get you a satisfied customer.

Even if you have no service calls, and things are a bit dull, you might call up your prospects and tell them that you have something new you wish to show them. Frequently, the curiosity of the owner will get the better of him, and he will allow you to "show him." Then, all you require is a few sets of tubes, and the rest will be easy.

I have listed in the paragraphs below, a few of the old tubes which may be replaced almost immediately, without major structural changes to the set. It will give the Service Man a good idea of just how important the new tubes are, so far as he is concerned, and of his increase in income during the next few months:

227—These old tubes may be replaced with the new 56 without any circuit changes. The advantages are smaller size bulb; lower filament-current drain (from 1.75 to 1 amp.) which is especially useful with poor power transformers, or where you may want to add more tubes without increasing the drain from the power unit.

224—This tube may be replaced either by the 57 or 58. In some cases it may be desirable to replace the primary of the R.F. transformer with one of higher impedance, or the set may be worked as is, although not quite as efficiently. If the 57 is used, the volume control should be changed to the cathode-circuit instead of the screen-grid

circuit, and the socket should be changed to the 6-prong type. By using this tube, the amplification of the set will be increased considerably. These tubes are also better detectors than the 224. In addition to this, if the 58 is replacing the 224, the variable-mu action is also obtained. Of course, the sockets must be changed to the 6-prong type, and the volume control placed in the control-grid circuit. Another advantage of the use of the new tubes is the lower filament-current drain (from 1.75 to 1 ampere). If additional tubes are to be added, the total drain from the power unit is not increased.

280—This is a full-wave rectifier tube. In receivers where greater gain must be had to obtain satisfactory reception, it may be replaced by the new, mercury-vapor 82. This tube has an internal drop of only 15 volts which may increase the D.C. output voltage as much as 100 volts, in some cases. The increased voltage so secured may increase the volume of many receivers. No socket changes are necessary, but a small R.F. choke (85 millihenries) should be connected in the center tap of the high-voltage winding.

Detectors—Clear reception and high gain are the advantages to be obtained by the use of the new 55, special detector tube. This tube is a combination diode detector and triode amplifier tube, and is therefore called "Duo-Diode Triode." This may be installed in any receiver in place of the usual detector tube by merely changing the socket to the 6-prong type. A few additional resistors and condensers are necessary to complete the job. In the 6.3-volt line, the 85 may replace the usual detectors. Corresponding changes must be made.

If so desired, the 29, a special detector tube without triode amplification, may be used instead of the usual detectors. This tube is equipped with two separate cathodes and grids, with but a single plate. It really constitutes two triode tubes in one glass envelope. In the 6.3-volt line, the 69, which is identical with the 29, may be used. As before, the socket must be of the 6-prong type.

D.C. Receivers—For D.C. operated receivers where output is of paramount importance, it is desirable to replace old type tubes with the new 48. This new tube has many times the output of the older 238, and has the added advantage that the filament-voltage rating is 30 volts, thus reducing the amount of resistance necessary in the filament supply. The use of this tube, therefore, requires the revision of the filament connections.

There are, of course, a number of adapters on the market now which are required when using some of the new tubes enumerated above. These adapters should be carried by the Service Man so that he can demonstrate the new tubes to the customer right on the spot. There is nothing more convincing to the set owner than to hear his own receiver perform as he never heard it before. In most cases, the sale is made at a good profit, immediately.

HOW TO BUILD THIS \$5 METERLESS TUBE TESTER

S. D. PRENSKY

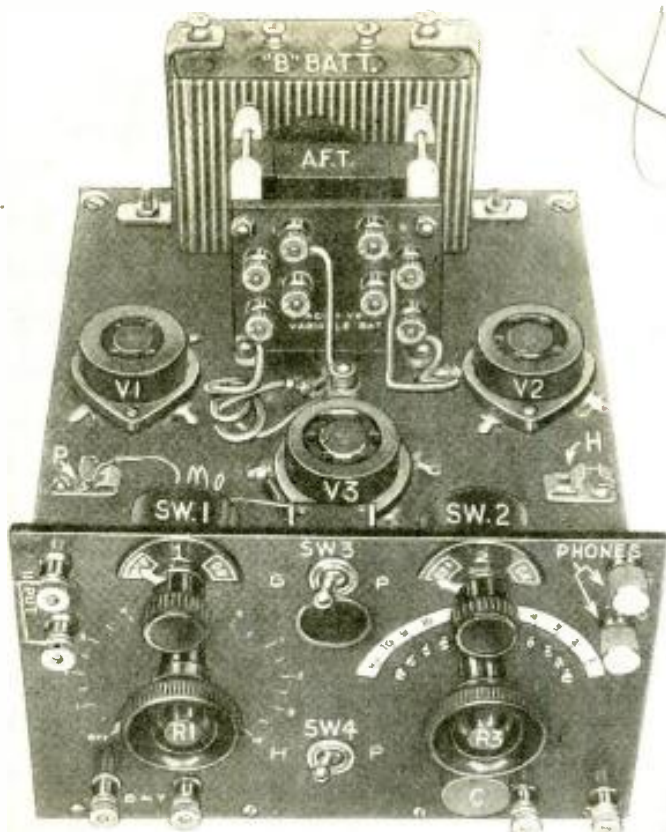

Fig. A

A general external view of the meterless tube tester. All notations refer to the schematic circuit of Fig. 2.

simple, regenerative circuit known so well to radio men. Since the transformer is tuned somewhere in the audio band, a musical note will

at least) by how *low* a plate voltage is required in order to *just* make the tube oscillate, compared to a good tube of the same type under identical operating conditions. This is the principle upon which our meterless tube tester works.

Now it is not necessary to measure

NOW, FOR THE FIRST TIME—A GOOD

EVERY Service Man seeks the ideal tube tester; and there seem to be as many ideals as there are Service Men. Since the ideal tester would test all tubes, cost nothing at all, have no mechanical and electrical difficulties, be easy to operate, etc., it could hardly be realized with ordinary testers. The writer, after considerable thought on the subject, has designed the *meterless* tube tester illustrated in the accompanying photographs labeled Figs. A, B, and C.

This tester is not the ideal; but for the purpose for which it is intended, it approaches the ideal closer than any other the writer has seen. This tester is capable of testing with extreme accuracy about 25 commonly used tubes; it may be built for approximately \$5.00; its construction is so simple that mechanical difficulties are nil; the circuit is a simple audio oscillator, and therefore no complicated switching arrangements are used; its operation is so simple "that even a child can operate it."

This is one of the few *meterless* tube testers which gives a *quantitative* comparison of the characteristics of a tube.

Circuit Design

The schematic circuit of the tester is based on the simple audio oscillator of Fig. 1. The primary of the audio transformer A.F.T. is used as a tickler and the secondary as the grid coil in a

be heard in the phones. Note that in the diagram shown, there is no "B" battery; the "A" supply also serves as the "B" supply. If a tube is poor, it cannot oscillate and therefore no sound will be heard in the telephone receivers. Now if a small "B" battery is inserted, there is a possibility that the tube may oscillate; in other words, the worse a tube is, the more "B" battery must be used in order to make it oscillate. Expressed in another way, the "goodness" of a tube is measured (in this tester,

the "B" voltage every time a test is completed. All that is required is a potentiometer connected across the "B" battery. The tube is inserted in the socket and the potentiometer varied until the tube *just* oscillates; the position of the potentiometer is then noted and compared with the position it *should* have for a good tube of the same type. In this manner a quantitative measure of the "goodness" of a tube is obtained. In our tester, the potentiometer is designated R3, and has ten taps, from 1

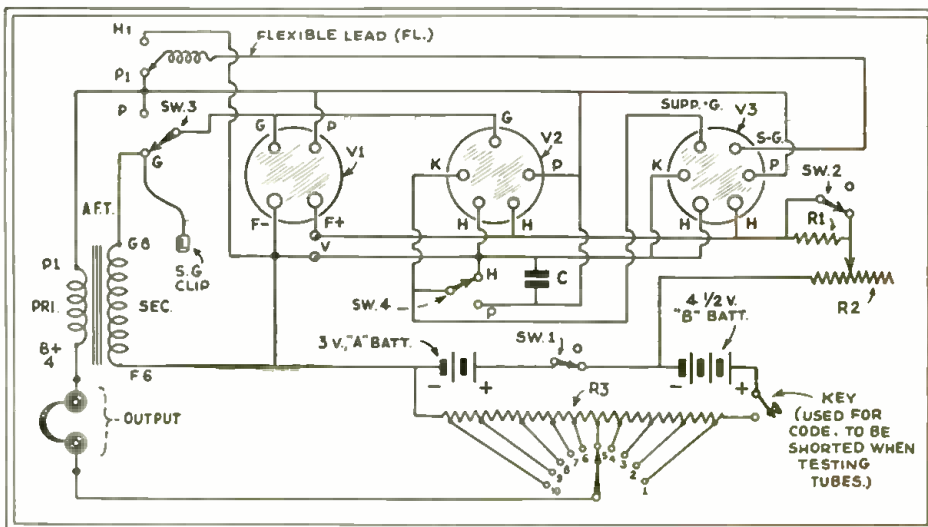

Fig. 2

Complete schematic circuit of the tester. The values of all parts are given in the List of Parts in the text.

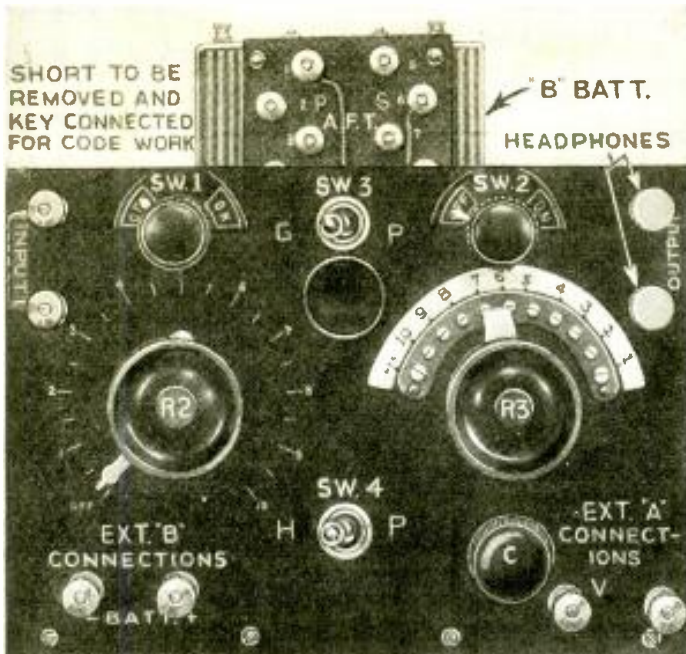

Fig. B
A panel view of the tester showing the controls.

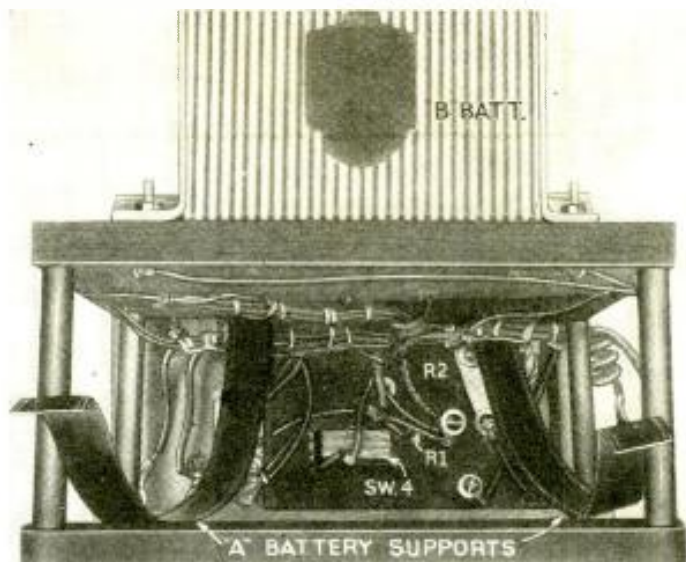

Fig. C
A rear view. The two dry cells are placed alongside one another, from left to right, and are supported by the metal straps.

to 10 inclusive. Tap No. 1 is connected to the highest voltage and tap No. 10 to the lowest or the zero point of the small "C" battery used as the "B" battery.

The final circuit is shown in Fig. 2.

of the potentiometer R3, which is connected across the 7.5-volts available. Thus the plate potential is varied, as previously described. No adapters are needed because a single 4-, 5-, and 6-prong socket are used, which is suffi-

METERLESS TUBE TESTER

Essentially it is the same as shown in Fig. 1, but includes the various switches and sockets required for easy manipulation. The location of all the parts shown in the diagram is designated by corresponding lettering in the photographs.

Description of the Circuit

Referring to the final diagram, we see that two dry-cells labeled "A" battery and a single 4.5-volt "C" battery are all the power supply necessary for complete operation. The pitch of the note is not at all important; the resistance R2 is used, not to vary pitch, but to adjust the filament potential to a "best" value for comparative purposes, resulting in a fixed setting for each type of tube. There is only one really important variable factor—the setting

of the potentiometer R3, which is connected across the 7.5-volts available.

The purposes of the other variable units are as follows: switch No. 1 is the off-on switch for the tester; switch No. 2, which is usually "on," short circuits the 10-ohm resistor R1, except when 2-volt tubes are used; toggle switch No. 3, usually in the G position, connects the grid prong of the sockets (the screen-grid in four-element tubes) to the plate of the tube, when thrown to the P position. The screen-grid clip, S.G., then connects to the cap of the tube. Toggle switch No. 4, usually in the H position, connects the K prong (which usually is the screen-grid in pentodes) to the plate of the tube, when thrown in the P position. Finally, binding posts are placed on the panel for a signalling key; since the tube

(Continued on page 425)

TUBE VALUE CHART for the METERLESS TUBE TESTER					
Type of Tube	All Switches Normal (N) unless otherwise noted	Setting of R2	Reading of R3 when Tube is		
			Good	Weak	Reject Below
'01A	Normal FL to P1	10	10-6	6-8	5
'12A	Normal	10	10-6	8-8	6
'22	SW. 1 to P clip on cap	1	10-6	5-6	6
'24	SW. 3 to P clip on cap	7	10-6	4-5	3
'25	Normal	6	10-6	5-6	6
'27	Normal	About 1-5 To	10-6	6-6	3
'30	SW. 2 OFF	1	10-6	4-5	6
'51	SW. 2 OFF	10	10-6	6-6	6
'52	SW. 2 OFF SW. 3 to P clip on cap	1	10-6	3-2	3
'53	SW. 2 OFF SW. 4 to P	10	10-6	4-3	3
'54	SW. 2 OFF SW. 3 to P clip on cap	5	10-6	3-2	2
'58	SW. 3 to P Clip on cap	9	10-6	4-3	3
'65	Normal	6	10-7	6-4	4
'66	SW. 6 to P	6	10-7	6-4	6
'47	SW. 4 to P	6	10-7	6-4	6
'51	SW. 3 to P clip on cap	7	10-6	4-3	3
55 Triode	Clip on cap SW. 4 to H FL to V	4	10-6	4-3	3
55 Diode Plate-1 Plate-2	Same as for a Triode	4	Switching SW. 4 to P should stop signal Switching FL to P1 should stop signal		
56	Normal	6	10-6	4-3	3
67	Clip on cap SW. 4 to P	4	10-6	4-3	3
68	Clip on cap SW. 4 to P	4	10-6	4-3	3
'71A	Normal	10	10-6	5-6	6

The tube chart. Tubes other than those listed may be tested and the results tabulated as described in the text.

- We believe this simple, low-cost tube tester (which may be fully constructed without phones or batteries for less than \$5.00) is the most practical tester for the Service Man with a small amount of "cash on hand."
- It uses no meters whatsoever, is simple to build and still simpler to operate. There is nothing in it to "wear out" or go out of order. In a word, it is realization of a dream!
- In seventeen tubes out of eighteen this tester agreed with an expensive tester of the meter type—in the eighteenth case, the meterless tube tester described here won out!
- Does this convince you?

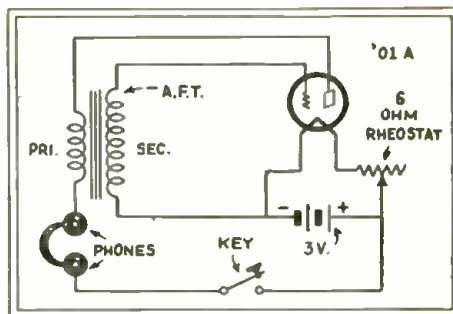

Fig. 1
Elementary circuit of the tester illustrating the theory of operation. A simple regenerative circuit is employed similar to the type used in ordinary tickler receivers.

THE LATEST RADIO EQUIPMENT

W. E. ANTENNA SYSTEM

AN antenna system capable of supplying 3,000 receiving sets from a single antenna has been designed and marketed by the Western Electric Co. In apartment, or in other multiple dwellings, where a number of radio sets must be operated from a single antenna, some means must be provided to properly distribute the signal so as to cause the least amount of interference possible. This is accomplished by the antenna system pictured in Fig. A, below.

The antenna is connected to a transmission line running from the antenna to the set, this line being connected to the antenna through a panel consisting of a lightning arrester, a terminal strip, and a matching impedance transformer (this latter unit being important in eliminating noise picked up by the antenna); this unit is shown in (1) of the figure. This transmission line terminates in an amplifier panel, shown in (2) of the figure. This amplifier contains filter units and is capable of supplying 750 radio sets; four such units may be used on a single antenna. The power for the amplifier unit is supplied by a special rectifier unit shown in (3) of the figure. Finally, another impedance matching transformer, shown in (4), matches the impedance of the line to that of the individual sets.

The impedance matching transformers are used between the aerial and the lead-in, and between the lead-in and the set. This subject is covered in an article in this issue of RADIO-CRAFT.

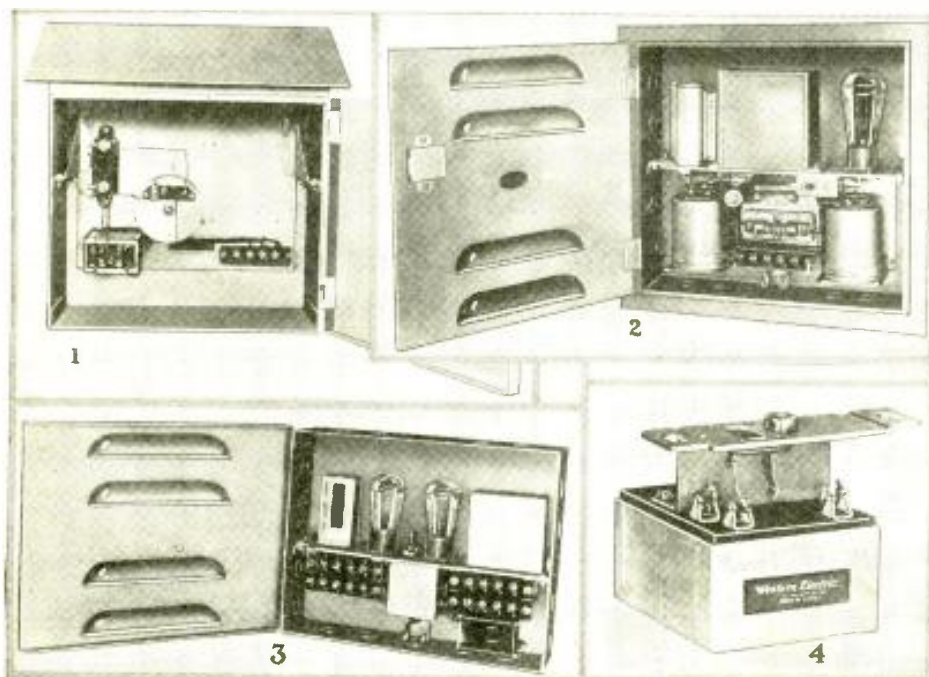

Fig. A
Photographs of the Western Electric antenna distribution outfit.

NON-POLARIZED ELECTROLYTIC CONDENSERS



Fig. B

THE Solar Mfg. Corp. announces the new electrolytic condenser, pictured in Fig. B, which is not polarized—the condenser may be connected to the line in any manner desirable. This is accomplished by using two coated anodes and a single dielectric, in a series connection. This reduces the total capacity to one-half its normal value when polarized.

FLASHLIGHT SCREW DRIVER

THE Burgess Battery Co. has now available a novel screw driver housing a battery and light, as shown in Fig. C. Depressing a button lights the light.



Fig. C
New Burgess flashlight screw driver.

LATEST TUBE CHECKER

ONE of the most inconvenient things the Service Man must contend with is the use of adapters with almost any type of equipment for testing tubes. The Radio City Products Co. has alleviated this condition by producing the Model 301 set tester illustrated in Fig. D. This tester is designed to test all the new 4-, 5-, 6-, and 7-prong tubes without any adapters. Another valuable feature of this tester is the provision for voltages of 1.5, 2.0, 2.5, 3.3, 5.0, 6.3, and 7.5 for any of the ten sockets on the panel. Both plates of the '80, 82, and 83 rectifier tubes may be readily tested. Grid shift, short, and gas tests may also be made.



Fig. D
New Radio City tube tester.

The Multidapter, described in our November issue, is now equipped with a plug and cord, and is known as the type 204.

CATHODE-RAY, SWEEP CIRCUIT

A COMPLETE cathode-ray circuit, ideal for laboratory and industrial uses, has been announced by the Wireless Egert Engineering Co., and is shown in Fig. E. A special fluorescent screen, 3½ inches in diameter, is used, making it specially useful for photographic work. A sweep circuit, used for obtaining a linear time axis is also provided. The power supply delivers a filament voltage of .5 to 1; a filament current of 5 amps.; an accelerating voltage of from 300 to 700; and a focusing voltage of -100; for the cathode-ray tube.



Fig. E
New Wireless Egert Engineering cathode-ray tube and sweep circuit.

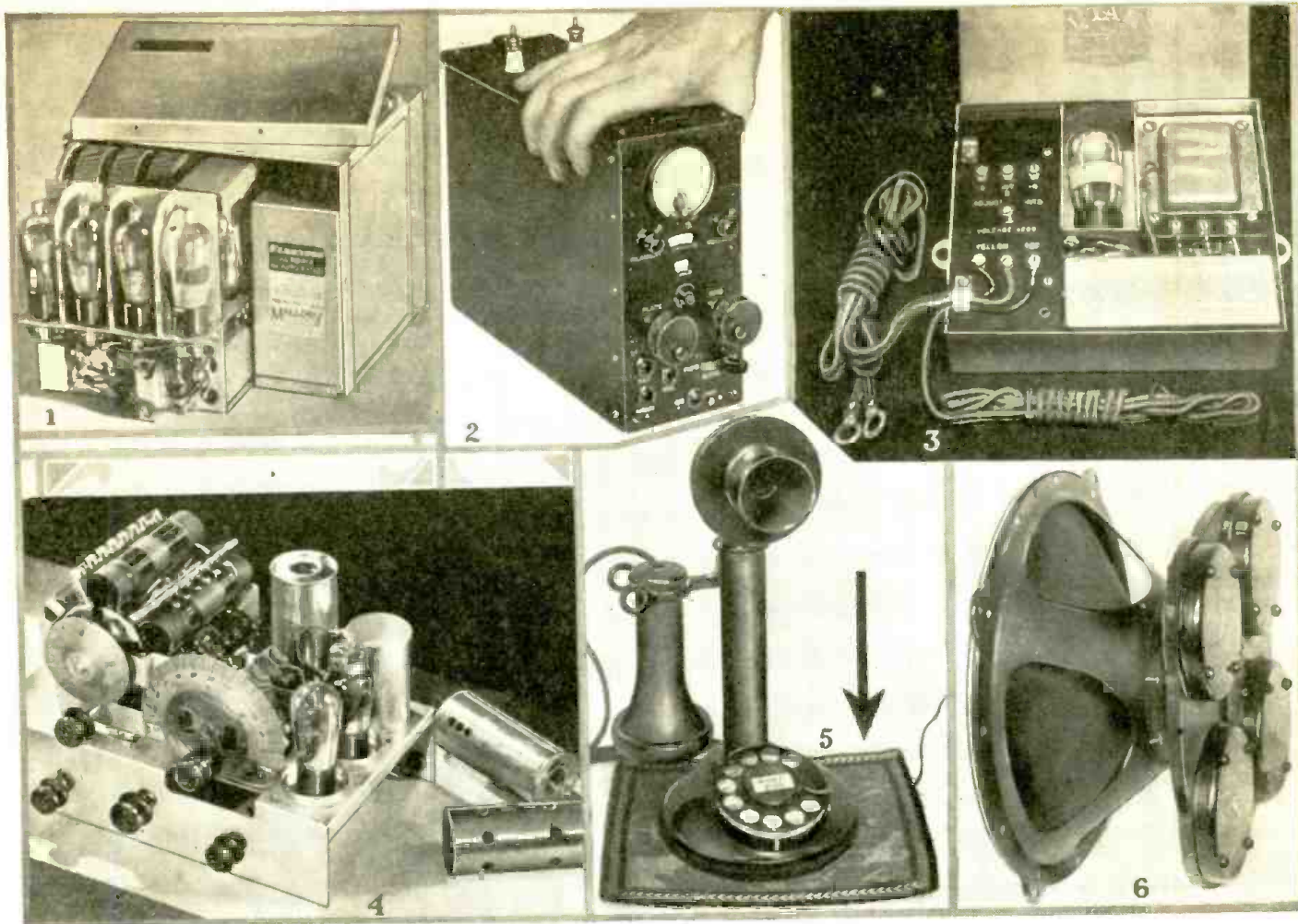

Fig. F

AUTOMOBILE RECEIVER

THE Galvin Manufacturing Corporation has fallen in line with the rest of the wise radio set manufacturers by producing an automobile receiver pictured in Fig. F at (1). This receiver does not use batteries or rotating machinery for its power supply, but the vibrator type "B" eliminator, a product of Mallory, which may be seen protruding slightly from its case.

In connection with "B" battery eliminators, it is well to mention that more and more of the auto receiver manufacturers are resorting to this type of "B" supply in preference to the other types because of the ease with which defective parts may be replaced.

TRANSMITTER—RECEIVER

FROM the laboratories of the RCA Victor Co., comes word of a new, tiny, short-wave radio telephone and telegraph receiver, in a single unit, for emergency and mobile communications over short distances.

The set, shown in (2) of Fig. F, weighs 22 pounds with the battery unit, and takes up about as much room as a moderate sized "B" battery.

The operation of the unit is simple. The changeovers from "transmit," "receive" and "telegraph" positions are accomplished with a single changeover key switch.

The circuit of the Transceivers is of the super-regenerative type.

NEW S. W. CONVERTER

ITEM (4) of Fig. F, is an illustration of the new Kolster S. W. converter. The features of this converter are: range, 1,500 to 13,000 kc.; five separate coil bands in a unique rotating switch arrangement, eliminating plug-in coils, dead-end losses, taps and the rest of the evils that besets the usual switching or coil changing methods.

The unit obtains its power supply by plugging into any Kolster International broadcast receiver. Any band may be selected by throwing the switch on the front panel. It is encased in a walnut finished cabinet which harmonizes with the current Kolster line of sets.

NEW AUTO "B" UNIT

THE Utah Radio Products Co. announces the new auto "B" unit illustrated in 3 of Fig. F. This unit has the following unique characteristics:

It is over 50% efficient; uses a gas-filled rectifier tube in a full-wave connection; it is quiet in operation and will remain so continuously if installation instructions are followed; the intermediate voltage may be adjusted with a screw driver and without replacing resistors; an automatic "A" power-control relay to control the unit from your present radio switch is built in every eliminator.

This unit will operate between wide battery-voltage fluctuations.

THE TELOPAD

MANY listeners do not like to use aeri-als. In the past, many devices have been used to obviate the use of them, and the unique item illustrated in (5) of Fig. F, is convenient, easy to install, and looks well (which is bound to please the housewife).

Just hang it on the telephone, or let the telephone rest on it as shown in the illustration, and your worries are over. It has the additional advantage that when the phone rings and you lift the phone to answer it, the volume of the radio automatically lowers—which in itself is a convenience. It is manufactured by the L. Chasoff Telopad Co.

NEW CRYSTAL SPEAKER

THE Brush Development Co., manufacturers of the crystal microphone, speakers, etc., have now available for use a four-unit crystal speaker, capable of handling 8 watts of electrical power, and delivering just a little less in acoustic power. The complete theory of operation of this type of loudspeaking unit was fully described in the July, 1932 issue of this magazine, and the reader is urged to refer to it.

This company produces crystal speakers in sizes ranging from 2 watts upward; the 8-watt size being illustrated in (6) of Fig. F. The crystal microphone was also described in RADIO CRAFT, in the November issue.

NEW TUBE ANNOUNCEMENTS

Four new tubes are now available. A double-grid output tube for automotive or D.C. use; a 2-volt R.F. pentode; a complete class B amplifier tube; and a new, mercury-vapor rectifier. Read the complete data given below.

52

Fil. voltage, 6.3; fil. current, .3-A.; plate voltage, 180; plate current, 42 ma.; grid bias, zero.

15

Heater voltage, 2; heater current, .2-A.; plate voltage, 135; S.G. voltage, 67.5; grid bias, 1.5.

19

Filament voltage, 2; filament current, .26-A.; plate voltage, 135; plate current, 10 ma.

KR-1

Heater voltage, 6.3; heater current, .3-A.; max. A.C. volts, 350; D.C. output current, 50 ma.

LOUIS MARTIN

CONTINUING our discussion of the new tubes available, we find this month a variety of tubes suitable for various classes of service. A number of the 6.3-volt tubes are of the filament type, and contain a new feature—two grids, which may be connected for use as either a class A or class B amplifier. We proceed now with a discussion of the latest tubes:

The ER-52

The ER-52, indicated in Fig. A, is a dual purpose, filament type, output tube designed for use in automobile receivers, and in power-operated, D.C. receivers. The widely different characteristics required for these two types of service are obtained by employing two separate grids, which are connected to separate base pins, as indicated in Fig. 1A.

For use in automobile receivers, the inner and outer grids are connected together, the tube then having the characteristics of a high mu, three-element tube, and being operated under familiar class B conditions with zero bias.

In power operated, D.C. receivers, the outer grid is connected to the plate, the tube then having the char-

acteristics of a low mu triode, and being operated under essentially class A conditions, *but also with zero bias*. These two sets of conditions are indicated in Fig. 1B. The plate voltage characteristics for high mu or class B connections are shown in Fig. 2. It will be noted that load lines are shown for resistances of 3,000 ohms, corresponding to 12,000 ohms from plate to plate for two tubes, and for 2,230 ohms per plate, corresponding to 9,000 ohms from plate to plate for two tubes. These load lines are drawn on the assumption of a 180-volt power supply. The higher value of load resistance is preferable for most operating conditions, where the input voltage does not exceed 21 volts. For input voltages higher than this value, the lower value of load resistance is preferable.

The measured output characteristics for two type ER-52 tubes operated under class B conditions are shown in Fig. 3. The values shown assume a plate to plate load resistance of 12,000 ohms, and for an input voltage supplied directly from a low impedance source. Under practical conditions, with the input voltage supplied by a '37 or 85 tube as a driver, an output of approximately 3 watts is

obtainable from the output stage. With reference to this curve, R_g is the grid resistance, P_o is the power output, and the second and third harmonics are so labeled.

Static curves for low mu or class A connections are shown in Fig. 4. As high plate circuit efficiency is not required in 110-volt, D.C. receivers, this tube has been designed to draw a relatively high plate current under these conditions for obtaining increased output. In this same figure, load lines are shown corresponding to load resistances of 1,950 and 2,500 ohms. These load lines are drawn for plate voltages which would allow 10 volts for the drop in the output transformer primary. The measured output characteristics for a single ER-52 are shown in Fig. 5. For the conditions of a 2,500-ohm load resistance, an input voltage is supplied directly from a low impedance source. Since the grid of the tube under these operating conditions swings positive and draws grid current during one-half of the cycle, this input stage must, in practice, be capable of delivering an appreciable amount of power to the output stage. The input circuit requirements are similar to those for class B operation, and precaution must also be taken to secure the proper phase relations be-

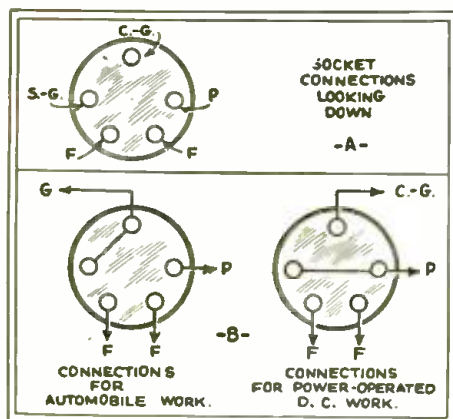

Fig. 1
Socket connections for the 52.

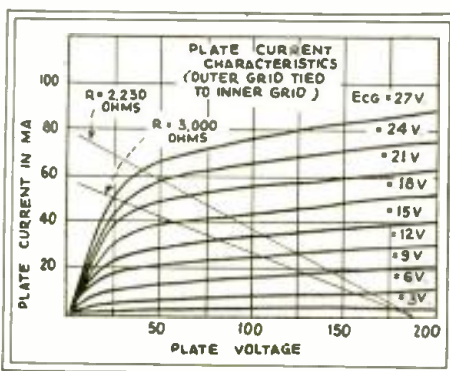

Fig. 2
Plate voltage characteristic of the 52 for the high-mu or class B connections.

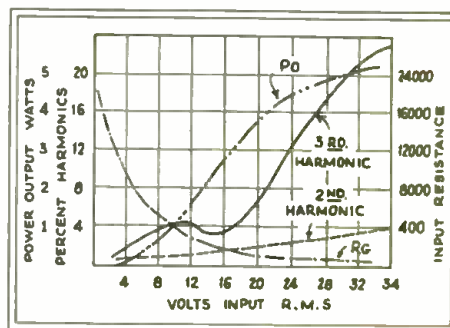

Fig. 3
Measured output characteristics for the 52 under class B conditions. The values shown assume a plate-to-plate resistance of 12,000 ohms.

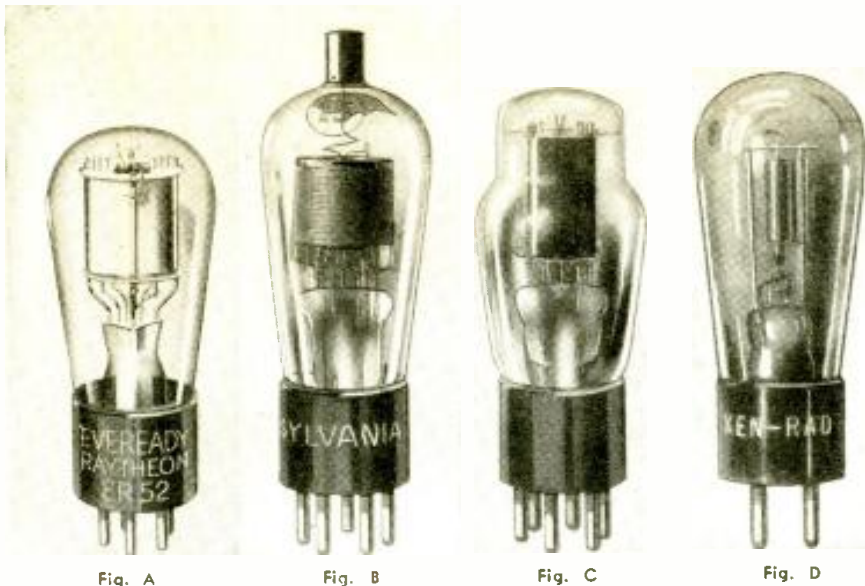

Fig. A

Fig. B

Fig. C

Fig. D

WHAT THESE NEW TUBES ARE FOR

The 52—a filament type output tube which may be used in automobile or D.C. power-operated receivers by merely changing the socket connections.

The 15—a 2-volt, heater type R.F. pentode. This is the first time a heater has been incorporated in the 2-volt line of tubes for producing constant emission with wide battery-voltage fluctuations.

The 19—An ingenious new tube which, by virtue of its double construction, is really two class B amplifier tubes in one. It is no longer necessary to use two tubes to secure class B operation—the single 19 is sufficient.

The KR-1—A new mercury-vapor rectifier especially designed for automotive use. It has a high breakdown voltage and is economical in operation.

tween input and output stages so as to reduce the second harmonic due to grid current. The 85 tube is suitable as a driver for a single output stage using a 52, and in this case, the voltage drop in the filament of the 52 may be used as grid bias for the driver tube. With this combination, an output of 1. watt is possible in practical receivers. Increased output may be obtained by the use of two 52 tubes connected in push-pull, with zero bias. With this combination, an output of 1. watt is possible in practical receivers. Do not confuse this class A connection with push-push connections which also use zero bias—*this is push-pull*. With this arrangement, the even harmonics, due to the flow of grid current in the input circuit, are balanced out. The output power is then in the neighborhood of 1.9 watts. This value may be increased if the driver tube is slightly overloaded.

The following characteristics as a class A amplifier obtain: Plate and outer grid voltage, 100; grid bias, 0; plate current, 42 ma. As a class B amplifier: Plate voltage, 180; grid bias (both grids) 0; plate current at no signal (for two tubes), 3 ma.; filament voltage, 6.3; filament current, .3-ampere.

The 15, Cathode Type R.F. Pentode

One of the main disadvantages of the 2-volt series of tubes is the filament construction. The heater type tubes are much more stable in operation, and the emission from the cathode does not fluctuate as rapidly as the emission from the filament type tube.

The first heater type tube with heater-current consumption low enough to bring it into the class of the battery-operated tubes is now made available by Sylvania in their announcement of the type 15, a pentode designed for R.F. amplification and detection. Limitations as to the physical size of the cathode make it necessary to take a higher current than is required for a filament-type of equivalent characteristics, but it is not anticipated that the 15 will be used in more than one or two sockets of the receiver where the circuit requirements are such as to make an independent cathode connection desirable. Some of the important applications of this tube are as follows:

(1) Combine first-detector—oscillator tube in superheterodyne receivers where an oscillator coupling coil is placed between cathode and ground.

(Continued on page 438)

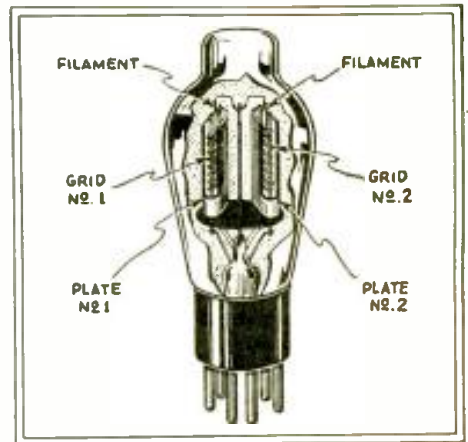

Fig. 8

Sketch showing the internal arrangement of the 19. Compare this with the socket connections given in Fig. 7, below.

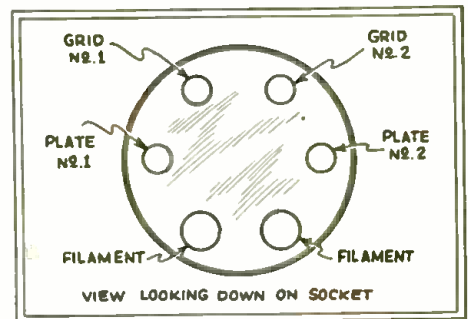

Fig. 7

Socket connections of the 19. Note the symmetrical connections of the grids and plates.

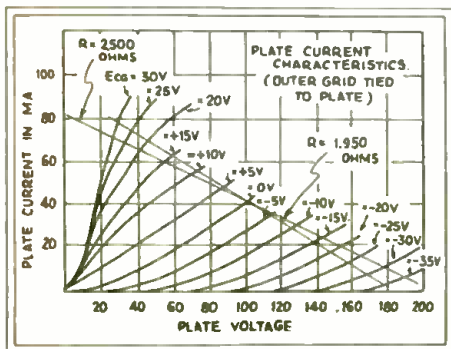

Fig. 4

Static curves for the low- μ or class A connections of the 52. In this case, load resistances of 1,950 and 2,500 ohms are assumed.

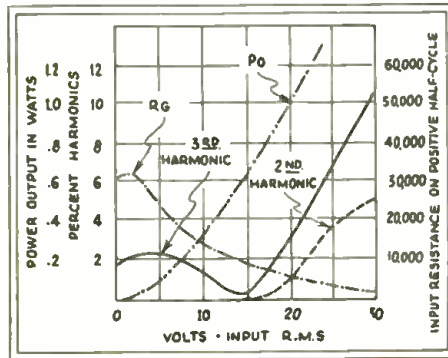

Fig. 5

Measured output characteristics for a single 52. For a 2,500-ohm load resistance, the input must be supplied from a low-impedance source.

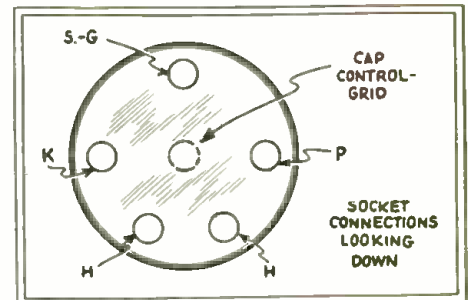

Fig. 6

Socket connections of the 15, a 2-volt, heater-type output pentode. Note that a 5-hole socket is employed. This tube is further illustrated in Fig. B above, and additional data is given in the text.

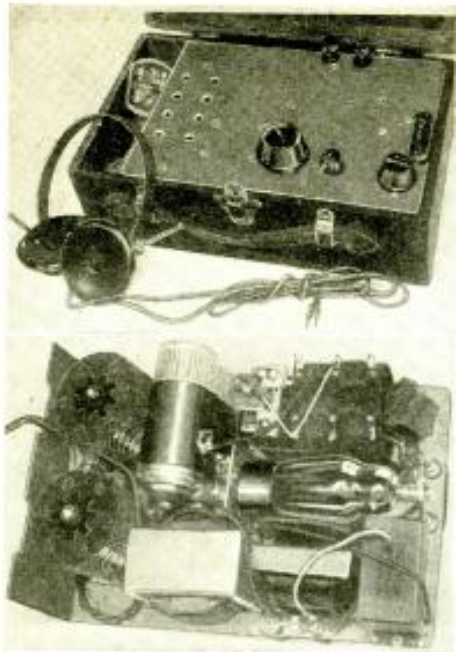

Fig. A, above
Outer view of the receiver. Note the fused plug at the left.
Fig. B, below
Under-chassis view. The location of all parts may easily be determined from this view.

IN Fig. A is illustrated a novel 1-tube portable receiver which is designed to operate on practically every type of commercial line-current supply; also, by means of a switch it is possible to receive police-wave stations in addition to the regular 200 to 550 meter broadcast programs; finally, by means of terminals provided for the purpose, it is possible to hear phonograph records through the use of an electromagnetic pickup. A rear view of the apparatus is Fig. B.

The schematic circuit, Fig. 1, is fundamentally that of the reflex receiver described and illustrated in the November, 1932, issue of RADIO-CRAFT, in the article, "How to Build the 'Diode-Triode' Reflex Receiver," by the writers. However, the former set was primarily designed as a battery receiver while the latter features a unique arrangement of a power supply system; also, there are a few variations in the actual tuner circuit.

Theory of Operation

The incoming signal is tuned in by condenser C1 in shunt to the secondary of L1, a standard "three-circuit"

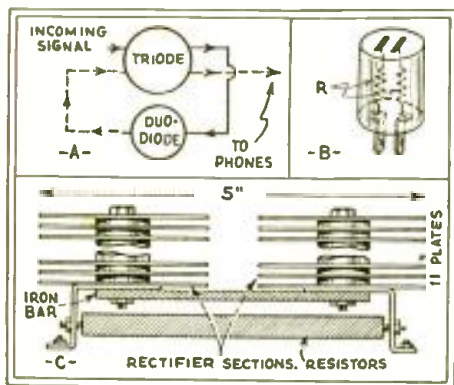

Fig. 2
Details of the receiver. They are fully discussed in the text.

WHY YOU SHOULD BUILD THIS RECEIVER

It may be used with any type of power supply available: D.C., A.C. of any frequency, or even batteries, if so desired.

The polarity of the line plug makes absolutely no difference—it works either way.

It uses the new 85, duodiode-triode in a regenerative, reflex circuit, making it very sensitive and selective.

A phonograph pickup may be easily connected to posts provided for the purpose, with no additional apparatus.

Tunes to the police wavelengths with no changes whatever.

BUILDING A 1-TUBE PORTABLE, UNIVERSAL CURRENT SET

R. D. WASHBURNE
and F. R. HARRIS

tuner. By means of switch Sw. the wavelength minimum may be reduced to include "police calls"—to many people, the most interesting band.

After being amplified by the triode portion of tube V, the R.F. signal path is completed through condenser C3 which connects to the cathode. At the same time the R.F. signal, in passing through the primary P of the fixed R.F. transformer, induces a voltage in the secondary S which is applied to the rectifier portion of the vacuum tube. In order to obtain the greatest voltage output from the signal-rectifier, the two plates are connected together in a "diode" hookup.

The pulsating D.C. which now flows through the primary of the A.F. transformer T induces in the secondary a potential which is applied to the triode portion of the duodiode-triode, type 85 tube. The sequence of operations is shown in simplified form in Fig. 2A.

Due to the fact that there is considerable loss in the diode type of rectifier, it is essential to use an A.F. transformer with a high ratio. The use of an instrument of this design is

not detrimental, as the low-impedance primary is a fair match for the diode portion of the tube. In this manner the voltage step-up of the A.F. transformer compensates to a certain extent the loss through the half-wave rectifier. The sensitivity and selectivity of the set as a whole are dependent almost entirely on local reception conditions and the size of the individual antenna.

To simplify the tuning requirements and to conserve space, an iron-core R.F. transformer was used to couple the output circuit of the 85 to the rectifier. In order to obtain even amplification over the entire tuning band, with sufficient volume for good headphone operation, it was necessary to use a shielded "screen-grid" type of the make specified in the List of Parts.

By shunting the primary of this R.F. transformer with the third or tickler winding of L1, it was found possible to utilize the feature of regeneration at all wavelengths; also, this connection made it convenient to compensate for a tendency toward

(Continued on page 442)

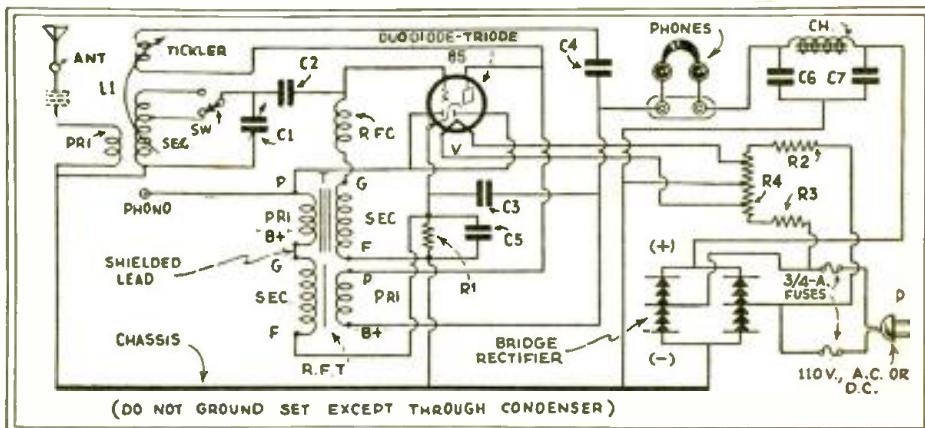

Fig. 1
Complete schematic circuit of the universal-current receiver described by the authors.

this

HOW TO BUILD A 13-WATT CLASS B AMPLIFIER

Here are complete constructional details of a 13-watt amplifier drawing 55 watts. Permits universal light socket or low-cost automobile generator installations.

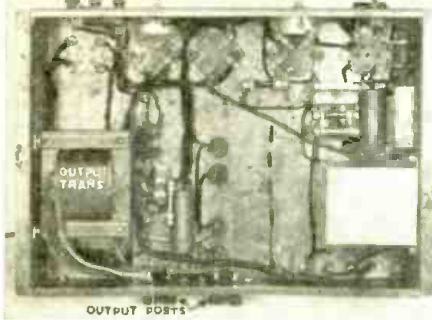
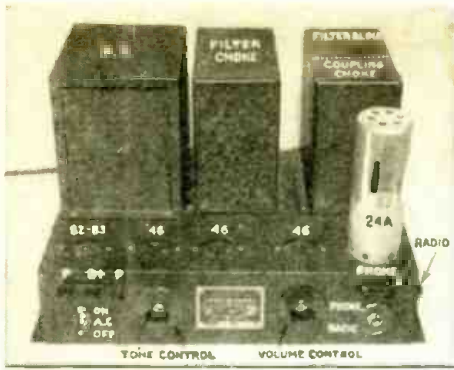

Fig. A

May be used with any standard speaker, with or without field coils; uses the latest tubes; operates from either a radio set, phonograph, or microphone. Uses class B tubes.

LEON J. LITTMAN*

THE new and rapidly-growing industry of building, renting, and selling up-to-date sound systems has produced an ever-increasing demand for better and more efficient A.F. power amplifiers for general P.A. work.

The amplifier to be described has the same maximum, continuous A.F. output as a conventional amplifier using type 750 tubes in push-pull and has been found quite ample for general work in the P.A. field. As this amplifier may

be used with the Auto A.C. Power Unit described in the November issue of this magazine (on page 276), it may therefore be called "universal." Using this power unit, the amplifier may be operated from a six-volt storage battery for automotive use (requiring a 6-volt field speaker) since it is rated at 65 watts and is perfectly capable of handling the amplifier to be described, which delivers 13 watts to the speaker.

Another advantage of class B amplification is the fact that the power trans-
(Continued on page 133)

*Chief Engineer, Coast to Coast Radio Corp.

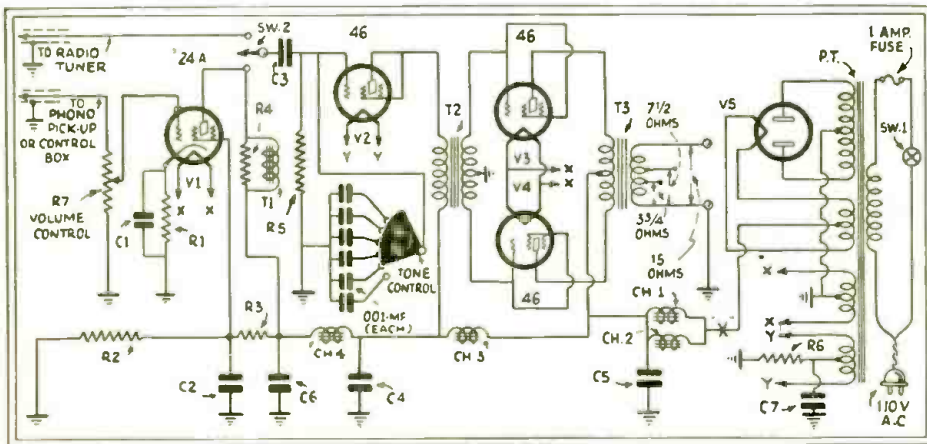

Fig. 1 Complete schematic circuit of the versatile amplifier.

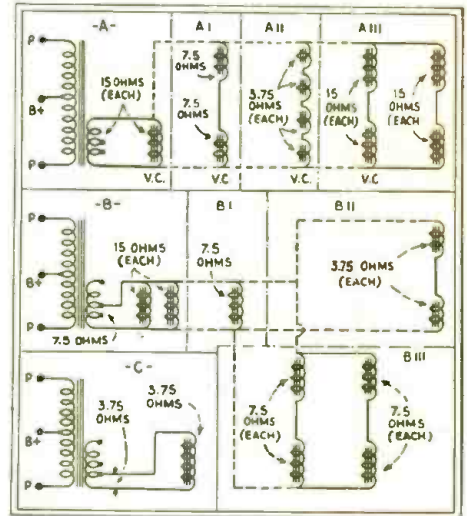

Fig. 2 Connections of various voice coils.

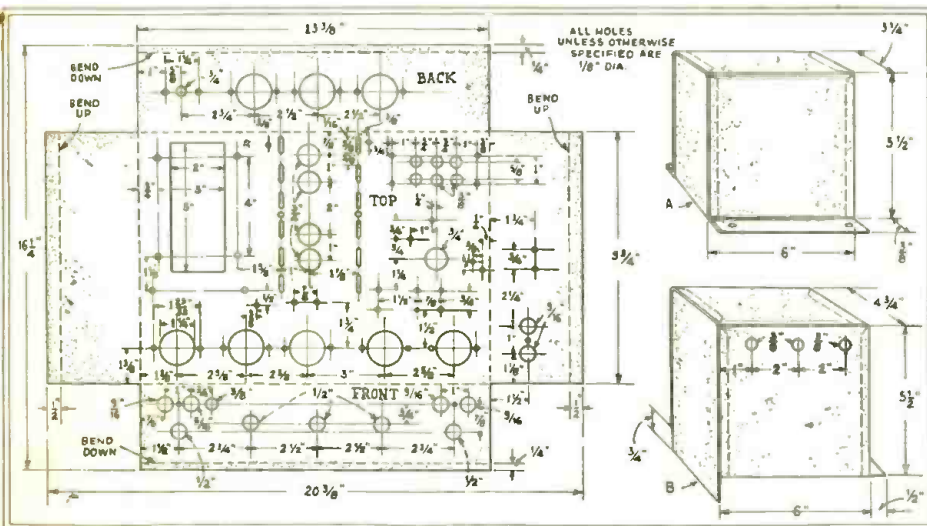

Fig. 4 Detailed drawing of the chassis. Dimensions of the shield coils are given to the right.

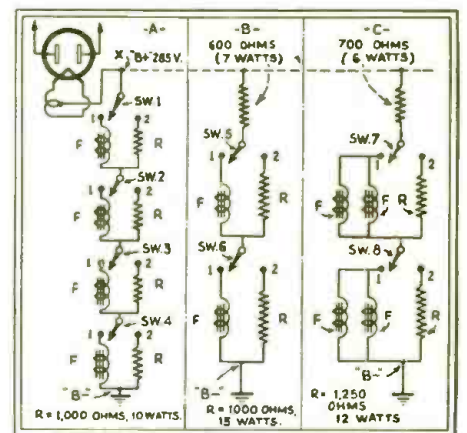

Fig. 3 Connections of various field coils.

USING THE V. T. VOLTMETER

Do you know how to measure the inductance and capacity of antennas, the capacity of electrolytic condensers, the regulation of power units? If not, read this article.

BERYL B. BRYANT

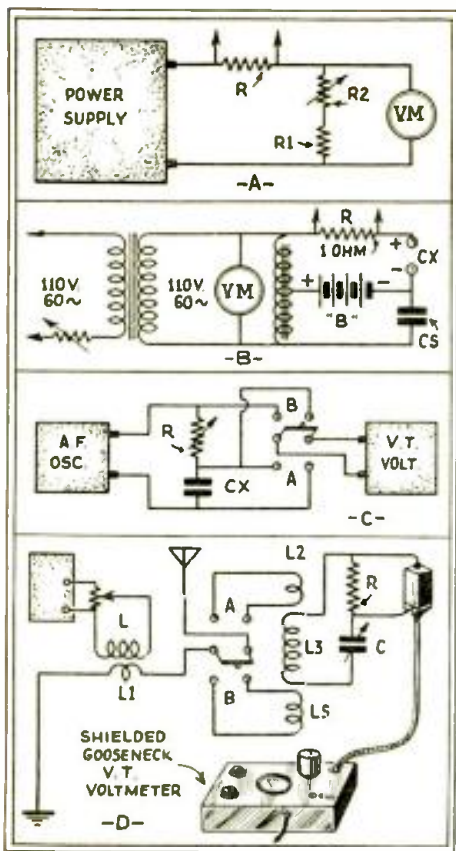

Fig. 4

At A, circuit for measuring voltage regulation; at B, connections for measuring the capacity of electrolytic condensers; at C, setup for measuring the impedance of electrolytic condensers; and at D, the circuit for determining inductance and capacity of antenna.

THE February, 1932, issue of RADIO-CRAFT contained a description of a two-tube, vacuum-tube voltmeter of exceptional design. The features of this voltmeter are such as to facilitate almost every type of measurement. The May, June, and August issues of this magazine contained a series of articles on the use of this voltmeter; this article, the last of the series, contains further measurement data.

Measurement of Voltage Regulation

In order to measure the voltage regulation characteristics of power supply devices, the setup given in Fig. 4A is used. The resistance R is a one-ohm, wire-wound resistor. The V. T. voltmeter is used to measure the voltage drop across this resistor in order that the accurate value of the current may be determined. The resistance of R1 is the same as the value of the bleeding resistor that is normally across the output of the system; this is generally 5,000 ohms. Resistor R2 is a variable unit of 0 to 25,000 ohms and should be capable of carrying at least 100 milliamperes. The meter VM is used to measure the voltage and may be of the 1,000-ohms-per-volt type, although the use of a V. T. voltmeter with a multiplier will give a more accurate result.

The procedure of the test is to adjust R2 to minimum resistance and the current through R, determined by the voltage drop, is plotted against the voltage as measured by VM. The

resistance of R2 is gradually increased in steps, with current and voltage readings taken. After the various readings have been made they are plotted on graph paper in order to give the voltage regulation curve.

Measuring Capacities of Electrolytic Condensers

The setup of the apparatus for the measurement of the capacity of electrolytic condensers is given in Fig. 4B. The V. T. voltmeter is connected across the one-ohm resistance R. The terminals B1 and B2 of the gooseneck V. T. voltmeter are used.

The A. C. current in amperes through the standard paper condenser Cs, the unknown electrolytic condenser Cx, and the one-ohm resistor R is determined by the voltage drop across R.

The capacity of the electrolytic condenser may be determined by the formula:

$$C_x = \frac{I \times C_s}{6.28 \times E \times C_s - I}$$

where Cx is the capacity of the electrolytic condenser in farads, Cs is the capacity of the standard paper condenser in farads, I is the A. C. in amperes through the two condensers in series, E is the A. C. voltage across the two condensers that is indicated by VM.

The above measurement is approximate as it is based on the impedance of the electrolytic condenser and neglects the electrolyte resistance. The value of the capacity obtained is the effective value and is less than the absolute or electrostatic value. The battery "B" is employed to polarize the electrolytic condenser.

Measuring Impedance of Electrolytic Condensers

In order to determine the impedance of electrolytic condensers the setup in Fig. 4C is employed. The resistor R is a standard, non-inductive variable resistance.

The D. P. D. T. switch is first set to the "A" position and the extent of indication noted on the V. T. voltmeter. The D. P. D. T. switch is then set to the "B" position and the resistor R varied until the indication on the V. T. voltmeter is the same as obtained with

the switch in the "A" position. The impedance of the condenser is then the value of resistance, in ohms, of the resistor R.

Capacity and Inductive Reactance

Capacity or inductive reactance, in ohms, may be determined by the same setup and in the same manner. Although an audio-frequency oscillator is desirable; a frequency source of 60 cycles will answer for most purposes.

Capacity and Inductance of Antennas

In order to determine the inductance and capacity of an antenna, the setup given in Fig. 4D is employed. Coil L is the radiating inductance of the oscillator, which has about 10 turns of wire of any diameter; L1 is the pickup coil of two turns; L and L1 should be shielded from the balance of the apparatus, L2 should be a two-turn coil; LS, a coil of known inductance; L3, the wavemeter inductance; C, the wavemeter capacity; and R a resistance of 5 ohms, across which is placed the V. T. voltmeter for resonance indication.

With the D. P. D. T. switch in the "A" position, the wavemeter is brought into resonance. The "LC" constant is now determined from the wavelength from the chart published in the June, 1932, issue of RADIO-CRAFT.

Next, the coil LS is connected in the circuit by throwing the switch to the "B" position. The inductance LS should be large enough to increase the fundamental wavelength approximately four times. The wavemeter is again brought into resonance and the LC constant again determined.

The capacity of the antenna is now determined from the formula:

$$C_a = \frac{LC_s}{L_s}$$

where Ca is the antenna capacity, LCs is the oscillation constant with Ls in the circuit, and Ls is inductance in microhenries.

The inductance of the antenna may now be determined from the following formula:

$$L_a = \frac{LC_f}{G_a}$$

where La is the antenna inductance in

(Continued on page 426)



An unusual use for P.A. Amplifiers for controlling automobile traffic. This booth is used by Chief of Police William Nichols, of Stratford, Conn. Here is a great idea for Service Men to take up with police chiefs in their own towns.



The Lafayette 250 Public Address Amplifier (right foreground), with a double button "mike" and stand, microphone amplifier stage (small box) and two 106 dynamic speakers.

THE Service Man with an eye to business will find prospects for permanent outdoor public-address amplifiers all around him. Let him take a ride around town some Sunday afternoon and make a list of public places of the following kinds: amusement parks, playgrounds and recreation centers, swimming pools, airports, race-tracks, ball parks and dancing and skating pavilions. Of course, some of them may already be equipped with P.A. systems, but it is certain that many are not.

If the information is not listed in the city directory, call up these places directly and inquire for the names of the owners. Of course, before you approach them you should visit each place and look over the situation carefully. Convince yourself, before you attempt

*Sound Engineer, Wholesale Radio Service Co., Inc.

In this article, the second of a series of six intended to supply the Service Man with money-making ideas, Mr. Short discusses permanent outdoor public address amplifiers and how to sell them. The first article, which appeared in the December, 1932, issue, covered permanent indoor installations. The third article, which will appear in the forthcoming February issue, will take up mobile, portable and temporary installations. Service Men with P.A. problems are invited to avail themselves of Mr. Short's experience in this field.

MAKING MONEY WITH P. A. AMPLIFIERS

HUBERT L. SHORT*

to convince the proprietor, that a P.A. amplifier is really necessary or desirable as a means of maintaining or increasing business. There's no sense in wasting time on an unprospective prospect—if you get what I mean.

Before you open your sales attack, you want to have a pretty good idea of what kind and size of amplifier and how many loudspeakers will meet the particular requirements. You should figure on a microphone, a phonograph turntable and pickup and plenty of outside wire. This latter detail is an important one, and many a Service Man has come to grief over it because he neglected to include it in his bill of materials. By the time you get finished draping wire around corners, up poles, over roof tops and down buildings, you may need several hundred feet.

Get Started Early

The most serious mistake that Service Men make in considering outdoor P.A. amplifier business is that they start "working" on their prospects too late. Perhaps the thought of people

splashing in swimming pools or cheering at the racetrack is remote from your mind when the snow is falling and the temperature hovers around 30, but the winter is the time to get started. It is during December, January, February and March that you must do your selling. Then the owners are not especially busy and have plenty of time to listen to your hot sales arguments on the benefits of P.A. amplifiers for their enterprises. As soon as spring rolls around they put on their overalls and start the annual overhauling, and then they're beyond hope.

A Novel P. A. System

Exceptionally effective use of a public address amplifier—one offering a valuable suggestion that many Service Men can readily capitalize on—is being made by Chief of Police William B. Nichols, of Stratford, Conn. One of the most heavily traveled express highways in the country runs through this town, and the control of traffic is naturally a considerable problem. To

(Continued on page 441)

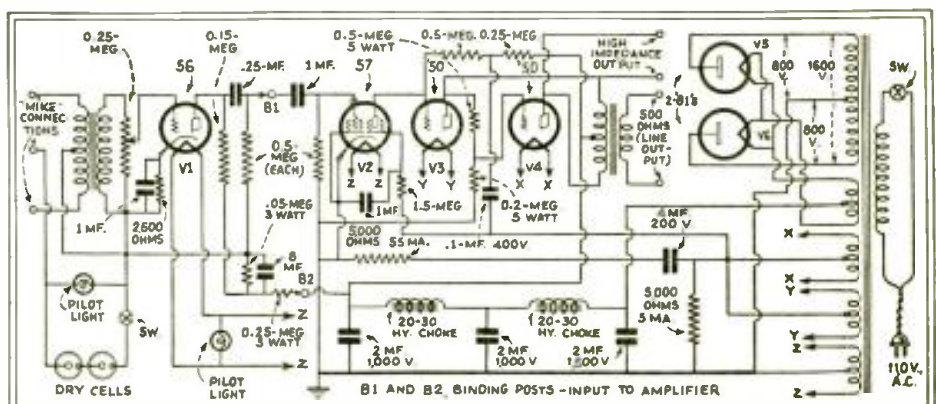

Full diagram of the 250 amplifier, with the microphone amplifier stage on the left. When the latter is used, the 1 mf. condenser and the .5-meg. leak in the amplifier are removed, and the connections bridged over directly as indicated.

RADIO-CRAFT'S LIST OF TRADE NAMES AND MODEL NUMBERS

So much confusion exists in radio regarding trade names and model numbers that RADIO-CRAFT painstakingly collected the data below and presents it to its readers

ALL AMERICAN MOHAWK CORP. Trade Name: LYRIC

Designation of chassis	Designation of complete set	Alternative designations
SA-65	Model SA-65 table Model SA-66 console	
SA-91	Model SA-91	
SA-130	Model SA-130	Channel Control
SW-80	Model SW-80	Short Wave
B-7	Model B-7	Battery Model
B-80	Model B-80	Battery Model
S-6	Model S-6 Midget Model S-61 Console Model S-62 Clock Model	
S-7	Model S-7	
S-8	Model S-8	
S-10	Model S-10	
S-63	Model S-63	
S-80	Model S-80 Midget Model S-81 Console	
DC-65	Model DC-65	Direct Current

ATWATER KENT MANUFACTURING CO.

Designation of chassis	Designation of complete set	Alternative designations
91	91-Auto	
93	93-Converter	
188	188-Lowboy	L Cabinet, 368 speaker
260	260-Semi-Highboy	M Cabinet
469	469-Lowboy	K Cabinet, 380 speaker
469D	469-D (D. C.)	K Cabinet, 469D speaker
469Q	469-Q Compact (Battery)	K Cabinet, 469Q speaker
480	480-Semi-Highboy	M Cabinet, 380 speaker
558	558-Compact	
558D	558-D (D. C.)	
558Q	558-Q Compact	
612	612-Semi-Highboy	M-2 Cabinet 1-324 speaker 1-326 speaker
627	627-Compact	
812	812-Highboy	B Cabinet 1-336 1-338

AUDIOLA RADIO COMPANY

Designation of chassis	Designation of complete set	Alternative designations
4-T	4 Tube T.R.F. Midget	
5-T	5 Tube T.R.F. Midget	
5T-SW	5 Tube T.R.F. Midget with short wave attachment	
8-T	8 Tube Super Console	
8-T	8 Tube Super Midget	
10-T	10 Tube Super Console	
10-T	10 Tube Super Midget	
11-T	11 Tube Super Console	

BROWNING-DRAKE RADIO CORP. Trade Name: BROWNING-DRAKE

Designation of chassis	Designation of complete set	Alternative designations
40 series	Model 40 (Console) Model 42 (Mantel) Model 44	200-550 meters 200-550 meters
80 series	(Phono Comb.) Model 80 (Console) Model 83 (Mantel)	200-550 meters 1000-3000 meters
90 series	Model 90 (Console) Model 92 (Mantel)	15-550 meters 15-550 meters

CANADIAN MARCONI COMPANY Trade Name: MARCONI

Designation of chassis	Designation of complete set	Alternative designations
Model No. 26 A & B	Mantel	Same chassis used in 26-C
26-C	Console	26 A & B
26-SW	Console Short Wave	
27-SW	Console Short Wave	Similar to 26-A.B.C.
28	Midget	
29 A & B	Mantel	
31	Console	
31-SW	Console	Similar to 31
32	Battery Console	1933 Models
32-B	Battery Console	
33	Battery Console	
33-AW	All Wave Battery Console	Similar to 33
34	Console	
35	Console	
36	All Wave Console	
37	All Wave Console	Similar to 36

CANADIAN WESTINGHOUSE CO., LTD.

Trade Name: WESTINGHOUSE

Designation of chassis	Designation of complete set	Alternative designations
RC	RC	RA, DA
Model 89	Model 89	Consolaire 89
Model 99	Model 99	Consolaire 99
Model 99	Model 99A	Consolaire 99A
Model 110	Model 110	Consolaire 110
Model 110	Model 120	Consolaire 120
Model 110	Model 90	Consolaire 90
Model 801	Model 801	Columaire 8
Model 101	Model 101	Columaire 10
Model 801	Model 802	Model 802
Model 122	Model 122	Consolaire Grand

COLUMBIA PHONOGRAPH CO.

Trade Name: COLUMBIA

Designation of chassis	Designation of complete set	Alternative designations
C-80A	C-81	Table Model
	C-83	Console
C-80B	C-84	Console-Twin Speakers
C-800A	C-85	Combination
C-90	C-93	Console
	C-95	Console-Twin Speakers
C-100	C-103	Consolelette
C-120	C-123	Battery Console

CROSLEY RADIO CORP.

Trade Name: CROSLEY

Designation of chassis	Designation of complete set	Speaker Number
127, 7-2	Adventurer	304
129-1	Alderman	318-3, 319-3
132-1	Ambassador	324-4, 325-4
124	Announcer	306
124-1	Announcer	321-5, 320-4
128-1	Announcer	298 or 308
77	Arbiter or 77B	264
125	Bigfella	291
135	Bigfella	312-4
131	Bonnieboy	284
124	Caroler	306
133 & 7-2	Caroler	312-4
134	Caroler	312-4
134 & 7-2	Caroler	312-4
124	Cheerio	287
132-1	Chief	325-4, 324-6

128	Chieftain (Battery)	235J or 235M
132-1	Commissioner	324-4, 325-4
130-1	Congressman	320-4, 326-4
146-1	Congressman	327-4, 325-4
26	Crony or 26-J (Battery)	273
76	Director or 76-A (D.C.)	263
77	Director or 77-A (A.C.)	264
125 & 7-2	Discoverer	291
135 & 7-2	Discoverer	312-4
133	Forty-five	312-4
136-1	Governor	320-4, 326-4
127	Happy Hour	304
127-1	Happy Hour	322-6, 320-4
129	Judge	309-4
129	Justice	309-4
146-1	Legislator	327-4, 325-4
125	Litlboy	291
135	Litlboy	312-4
125	Litlbella	291
135	Litlbella	312-4
53	Mate or 53-E (A.C.)	272
130	Mayor	310-4
146	Mayor	315-4
128	Mayor (Battery)	235J or 235M
124	Merrymaker	287 or 306
124-1	Merrymaker	321-5, 320-4
126-1	Merrymaker	298 or 308
134-1	Merrymaker	320-4, 323-5
54	New Buddy or 54-G (A.C.)	274
141	Nomad	313-3
53	Pal or 53-F (A.C.)	272
26	Partner or 26-K (Battery)	273
77	Phono-Automatic or 77-I	264
124	Playboy	287
126-1	Playboy	298
134	Playboy	312-4
134 & 7-2	Playboy	312-4
128	Playboy (Battery)	306
124	Playtime	321-5, 320-4
124-1	Playtime	298 or 308
126-1	Playtime	320-4, 323-5
134-1	Playtime	291
125	Playtime, Jr.	312-4
135	Playtime, Jr.	284-3
137	Pup	304
127	Reveler	214
90	Roamio	279
91	Roamio	295
92	Roamio	286
95	Roamio	333
96	Roamio	332
951	Roamio	249
84	Rondeau or 84-C	320-4, 326-4
136-1	Secretary	310-4
130	Senator	315-4
146	Senator	234
27	Showboy	234
28	Showboy	234
9	S. W. Adapter	249
84	Sondo or 84-D	301
127	Tenstrike	301
127 & 7-2	Tenstrike S.W.	284
131	Tynamite	313-3
141	Vagabond	272
53	Wood's Desk or 53-M	272

DE FOREST RADIO CORP.

Trade Name: DE FOREST CROSLEY

Designation of chassis	Designation of complete set	Alternative designations
608A	Windsor Model Console	25 cycle
608B	Windsor Model Console	60 cycle
608C	Berwick Compact Model	25 cycle
608D	Berwick Compact Model	60 cycle
708A	Cavendish Console Model	25 cycle
708B	Cavendish Console Model	60 cycle
851A	York Console Model	25 cycle
851B	York Console Model	60 cycle
851C	Mayfair Compact Model	25 cycle
851D	Mayfair Compact Model	60 cycle

902A	Montrose Console Model	25 cycle
902B	Montrose Console Model	60 cycle
140	Balmoral Console Model	Universal 25 & 60
801	Embassy Console Model	Battery (Air Cell)
802	Embassy Jr. Compact	Battery (Air Cell)

ECHOPHONE RADIO MFG. CO.
Trade Name: ECHOPHONE

Designation of chassis	Designation of complete set	Designation of chassis	Designation of complete set
D	D	16	16
E	E	17	17
S-3	S-3	18	18
4	4	20	20
S-4	S-4	35	35
5	5	40	40
S-5	S-5	50	50, 55
10	10	60	60, 65
12	12	70	70, 75
14	14	80	80
15	15	90	90

FADA RADIO & ELECTRIC CORP.
Trade Name: FADA

Shop Type	Designation of complete set	Type
A	265-A & RR-65	Battery
AP	265-CA & RP-65CA	A. C.
B	475-A & 45/75-A	Battery
BP	475-CA & 45/75-CA	A. C.
C	480-B & 50/80-B	Battery
D	10, 11, 30 & 31	A. C.
DC	12	D. C.
E	50, 70, 71 & 72	A. C.
Rev. E	75 & 77	A. C.
F	460-A & R-60	Battery
G	16, 17 & RP-17	A. C.
GA	20	A. C.
GB	32	A. C.
GC	18	D. C.
H	480-A, 50/80-A & R-80	Battery
K	35	A. C.
KA	41, 42, 44, 46 & 47	A. C.
KB	81, 82, 84, 86	D. C.
KE	122	Air Cell
KF	43	A. C.
KG	761, 762, 764 & 766	A. C.
KO	51	A. C.
KO-220	251, 253 & 257 (257 comb.)	D. C.
KOC	53 & 57 (57 comb.)	A. C.
KOC-110	171, 173	D. C.
KOC-222	Chassis	
KOF	512, 532, 572 (220 volts)	A. C.
KU	45	A. C.
KW	48 & 49	A. C.
KX	61 & 63	A. C.
KY	66	
Rev. K	35-B	A. C.
M	25, M-180, 15-M, 35-M	A. C.
Rev. M	25, M-250, 35-C, 7-MA	A. C.
O	22	Battery
P	40	A. C.
RA	74, 76, 83, 87, 88, 89, 97	A. C.
RC	78 & 79	A. C.
RE	73 & 85	A. C.
RF-110	Chassis	D. C.
RF-220	Chassis	D. C.
RF	732, 852	A. C.
RG	55	
RN	93 & 95	

Besides the model number of the receivers there are letter designations. These letter designations are the letters which appear after the serial number of the receiver and they help designate the type chassis.

In other words, a receiver bearing serial number 0000-RE will indicate that the chassis could be one from either a model 73 or 85 as attested by the attached sheet.

FRESHMAN RADIO CORP.

CORRESPONDING MODEL NUMBERS EARL and FREED RECEIVERS

On the corresponding sets, as listed below, the mechanism is identical. There is a slight difference in cabinets.

Earl 21	equivalent to Freed 56
Earl 22	equivalent to Freed 55
Earl 31	equivalent to Freed 78
Earl 31-S	equivalent to Freed 78-S
Earl 32	equivalent to Freed 79
Earl 32-S	equivalent to Freed 79-S
Earl 41	equivalent to Freed 95
Earl 33	equivalent to Freed 90
Earl 33-S	equivalent to Freed 90-S
Earl 24	equivalent to Freed 65
Earl 121	equivalent to Freed 53

GRIGSBY GRUNOW CO., INC.

Trade Name: MAJESTIC

Designation of chassis	Designation of complete set	Alternative designations
10	11	Short Wave Converter
20	21, 22, 23	
30	31	
50	51, 52	
55	56	Ardmore
55	57	Berkshire
55	58	Viking (Short & Long Wave)
10	58	Viking
60	61, 62	
90-B	90, 91, 92, 93	1930 Models
90	91 & 92	1929 Models
100	101	
100-B	102, 103	
110	110	Auto
120	121	
120-B	123	
130-A	130, 131, 132	
15	151	Havenwood
15	153	Ellswood
15-B	154	Fyfewood
150	155	Castlewood
15	156	Sherwood
160	163	
180	181	
200	201	Sheffield
200	203	Fairfax
200	204	Explorer (Short & Long Wave)
10	204	Explorer (Short & Long Wave)
210	211	Whitehall
210	214	Stratford
210	215	Croydon
220	221	Collingwood, 1932
220	223	Abbeywood, 1932
230-A	233	
25	251	Cheltenham, Oct. 1931
25-B	251	Cheltenham, Nov. 1931
25	253	Brentwood, Oct. 1931
25-B	253	Brentwood, Nov. 1931
25	254	Brucewood, Oct. 1931
25-B	254	Brucewood, Nov. 1931
290	291	Madison
290	293	Adams
10	294	Monroe (Short & Long Wave)
290	294	Monroe (Short & Long Wave)
300	303, 304, 307	
310	311, 314	
320	324	
35	351	Collingwood, 1931
35	353	Abbeywood, 1931

GULBRANSEN COMPANY

Trade Name: GULBRANSEN

352	Model 3521
Five tube A. C.	Model 3525
872	Model 8726
Seven tube A. C.	
392, Nine tube Battery	Model 3925
322	Model 3225
Twelve tube A. C.	Model 3226
3622, Six tube Auto	Model 3622
3722, Seven tube Auto	Model 3722

HOWARD RADIO COMPANY
Trade Name: HOWARD

Designation of chassis	Designation of complete set	Alternative designations
Style K	Model K	
Style H	Model H	
Style M	Model M	
Style PH	Model 500	
	De Luxe...with Short Wave	
	Model 501	

KELLOGG SWITCHBOARD & SUPPLY CO.

Trade Name: KELLOGG

Designation of chassis	Designation of complete set	Alternative designations
504	504-505-506	Wave Master
507	507-508	Battery Sets
510	510-511	
514	514-516-517	
515	515-518-519-520-521	
523	523-526	
524	524-527	1-528
533	533-534-535-536	125 eyle

KOLSTER RADIO INC.

Trade Name: KOLSTER

All models carry combination letter-number symbols only.

LANG RADIO CORP.

Trade Name: LANG

Designation of chassis	Designation of complete set
AA5	Junior AA5 table model
AA6	Senior AA5 table model
AA6	Junior AA6 T. M.
AA6	Senior AA6 T. M.
DC6	Junior DC6 T. M.
DC6	Senior DC6 T. M.
MA8	MA8 T. M.
MD8	MD8 T. M.
SA9	
SD8	

NATIONAL COMPANY, INC.

Trade Name: NATIONAL

Designation of chassis	Designation of complete set
SW58AC	5 Tube A. C.
	Short Wave Receiver
SW34DC	5 Tube D. C. Battery
	Short Wave Receiver
SW3DC	3 Tube D. C. Battery
	Short Wave Receiver
SW3AC	3 Tube A. C.
	Short Wave Receiver
NC5	5 Tube Short Wave Converter
NB32	5 Tube Broadcast R. F. Tuner
H. F. R.	5 Meter Receiver
H. F. C.	M. C. Converter

PIERCE AIRO, INC.

Trade Name: PIERCE AIRO-DEWALD

Designation of chassis	Designation of complete set
B.A.C.	B.A.C.-4, B.A.C.-7, B.A.C.-8
K.A.D.	K.A.D.-8, K.A.D.-4, K.A.D.-7
50	50-4, 50-7, 50-8
B.A.H.	B.A.H.-1, B.A.H.-2, B.A.H.-400
	B.A.H.-212, B.A.H.-42
K.A.F.	K.A.F.-1, K.A.F.-2, K.A.F.-400
	K.A.F.-212, K.A.F.-42
B.A.M.	B.A.M.-6, B.A.M.-212, B.A.M.-42

PILOT RADIO & TUBE CORP.

Trade Name: PILOT

Designation of chassis	Designation of complete set	Alternative designations
10	1010	Dragon Monarch
10	8810	Dragon Emperor
39	7639	Twentieth Century
39	8239	Golden Arrow
43	8443	Twin Coupler Brand Liberty
43	8643	Armada
51	9251	Twin Coupler Brand Rainbow
55	9255	Corsair
55	9855	Twin Coupler Brand Captain Kidd

READRITE METER WORKS

Trade Name: READRITE

Designation of chassis	Designation of complete set	Alternative designations
406	60 Cycle Tube Tester	
407	60 Cycle Tube & Short Tester	
408	25 Cycle Tube Tester	
409	25 Cycle Tube & Short Tester	
500	0 to 10,000 Ohmmeter	
502	0 to 40, 0 to 10,000 Ohmmeter	
550	Oscillator	
610	Set Tester	
710	Set Tester	
900	A.C. & D.C. Current Measuring Device	
1000	Point to Point Tester	

SEARS ROEBUCK & COMPANY

Trade Name: SILVERTONE

1932-1933 line

Designation of chassis	Designation of complete set Name	Model	Alternative designations
5 tube			
Battery Super		1620	Midget Cab.
8 tube			
Bat. Allwave Sup.	Wellington	1520	Midget Cab.
8 tube			
Bat. Allwave Sup.	Westminster	1574	Console Cab.

(Continued on page 440)

HOW TO MAKE A GENERAL-PURPOSE TEST METER

A description of an extremely versatile test meter which not only measures resistance, but inductance and capacity as well. Complete construction details and calibration data are given below, by the author.

PAUL SHALLCROSS, E.E.*



Fig. A
External view of the versatile tester.

EVERY technician, whether he is interested in the design, construction, or service of radio apparatus, will find the following description of a general-purpose meter well worth reading. The instrument is extremely compact and worthy of a place in any radio laboratory. The writer wishes to stress the point that the accuracy of the completed instrument is dependent entirely upon the accuracy of the components; in other words, an inaccurate meter will nullify the use of accurate resistors, and vice versa.

The completed instrument is illustrated in Fig. 1; its schematic circuit is Fig. 1; a drilling layout is shown in Fig. 2.

In the operation of an instrument of this type, it is necessary that care be taken to set the switches correctly, as

*Engineer, Shallcross Mfg. Co.

damage may be done in attempting to read D.C. values when A.C. is employed. Likewise, damage will result if the instrument is set as an ammeter and is connected across a potential source as a voltmeter.

Voltage and Current

Damage to this general-purpose meter is avoided by starting all measurements with the three switches at the bottom pointing down from the center of their travel, and the output-meter switch turned to the right, or out of the circuit. Then, the A.C.-D.C. switch is set to the desired position. If set to D.C., the voltage and current ranges may be obtained by having the MA.-V. switch set on the MA. or V. position.

If a reading is obtained without depressing any push-buttons (A to F), the range is 1,000 ma. or V as the case may be. If the instrument is adjusted for D.C. volts and the deflection is not too great, press button C for the 250-volt range. If the deflection is still too small, press button B for the 50-volt range or button A for the 5-volt range.

On the other hand, if the switches are set to D.C. and MA. and buttons F, E, and D are depressed in the order given, the current ranges will be 100, 10, and 1. ma. respectively. Operating the push-buttons in this order will serve to prevent excessive current passing through the meter and causing damage. When the A.C.-D.C. switch is set to A.C., only A.C. voltages may be measured. Therefore, do not attempt to make current measurements on A.C.

Resistance (D.C.)

To measure D.C. resistance, set the A.C.-D.C. switch to D.C. and set the IMP.-RES. switch to RES. Then connect the unknown resistance across the binding post terminals as shown in sketch A, Fig. 3. Depress buttons F, E, or D, and select the meter reading nearest the center of the scale. Refer this meter reading to the D.C. resistance curve shown in Fig. 3. If button F is depressed, divide the resistance reading by 100. If button E is depressed, divide by 10. If button D is depressed, the reading will be direct as indicated.

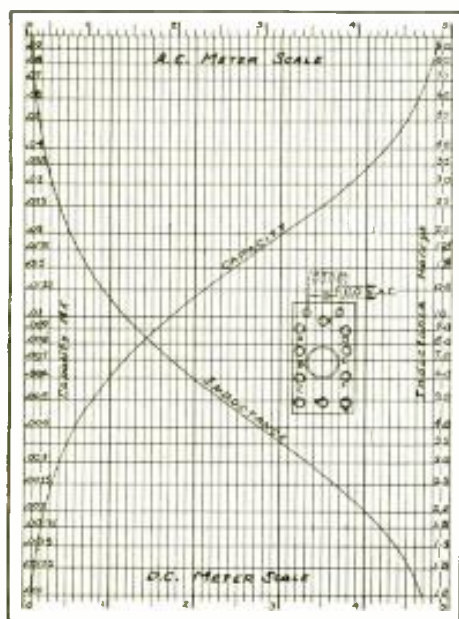

Fig. 4
Actual inductance and capacity calibration curves of the tester. The posts for the external inductances or capacitors are shown in the insert.

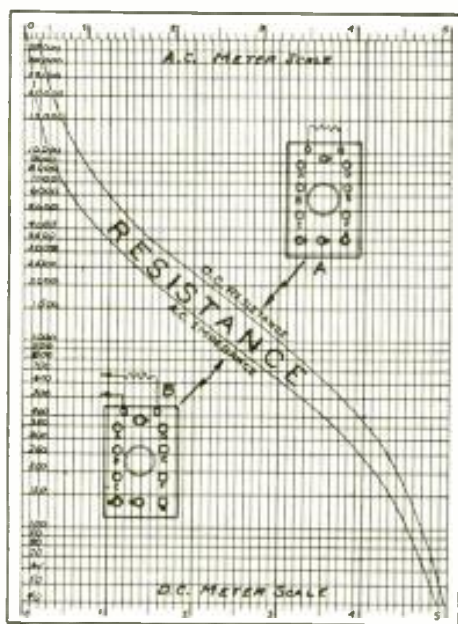
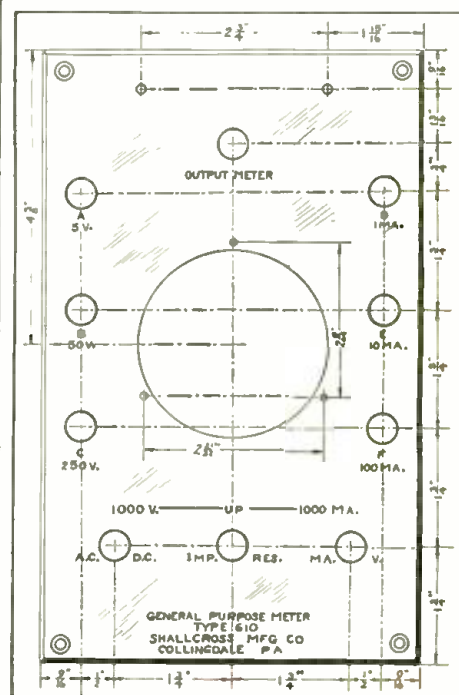

Fig. 3, above
Actual resistance and impedance calibration curves.

Fig. 2, right
Panel layout of the tester. Compare this with the photograph.



WHAT THIS METER CAN MEASURE

It has the following D. C. Voltage ranges: 0-5; 0-50; 0-250; 0-1,000 volts.
 It has the following direct current ranges: 0-1; 0-10; 0-100; 0-1,000 ma.
 A. C. voltage ranges of 0-5; 0-50; 0-250; 0-1,000 volts are possible.
 The following resistance ranges are available: 0-100; 0-1,000; 0-10,000 ohms.
 The following impedance ranges are available: .01; .1; and 3 megohms.
 The following inductance ranges are available: 0-100; 0-1,000; 0-10,000 henries.
 Capacity measuring ranges of 0-.001; 0-.1; 0-1; and 0-10 microfarads.
 Output meter ranges of 0-5; 0-50; and 0-250 volts are also possible.

Resistance (A.C. Impedance)

Impedances may be capacity, inductance, or resistance. When the impedance to be measured is resistance, the value of this resistance may be determined by setting the A.C.-D.C. switch to A.C. and the IMP.-RES. switch to IMP.; then connect 110 volts A.C. in series with the unknown resistance and the meter as indicated in sketch B, Fig. 3. Refer the meter reading to the A.C. impedance curve, Fig. 3, and multiply the resistance reading by 100. If button B is depressed, multiply the resistance reading by 10. If button A is depressed, the unknown resistance will be direct as indicated. Never set the switches to A.C.-RES.

Inductance and Capacity

When the impedance is composed of inductance or capacity, the inductance or capacity may be determined by setting the A.C.-D.C. switch to A.C. and the IMP.-RES. switch to IMP., then connect the 110 volts, 60 cycles A.C. in series with the unknown inductance or capacity and the meter as indicated by the sketch in Fig. 4.

Referring the meter reading to the inductance curve of Fig. 4, multiply the inductance reading by 100. If button B is depressed, multiply the inductance reading by 10. If button A is depressed, the unknown inductance will be direct as indicated. (The highest inductance reading is not often used except for power transformer work.)

Capacity

If no buttons are depressed, refer the meter reading to the capacity curve, Fig. 4, and read the capacity direct as indicated. If button B is depressed, multiply the capacity reading by 10. If button A is depressed, multiply the capacity reading by 100.

Output Meter

An output meter is an A. C. voltmeter used in radio set servicing. The

impedance remains constant over the different ranges. A common impedance to use for this purpose is 5,000 ohms. Output readings within the range of 5 volts are made when the meter is set on the 5-volt, A.C. range

The slight variation in impedance for the different ranges is unimportant as output meter readings are generally relative.

The writer will be glad to assist experimenters who may encounter "resistance problems" in the design of laboratory apparatus.

The following tabulation is appended as reference for the above-described operations:

D.C. Volts: D.C.—V.
 D.C. Potential: D.C.—MA.
 A.C. Volts: A.C.—V.
 Resistance (0-10,000): D.C. RES.—
 Resistance (100-3 megohms): A.C. IMP.—
 Inductance (1-10,000 henries): A.C. IMP.—
 Capacity (.001-10 mf.): A.C. IMP.—
 Output Meter: A.C.—V. Out. Mtr.

Resistor kit No. 610, recommended as sufficiently accurate for this general-purpose meter, contains 15 resistors having the following values:

Code	Resistance	Type
A—	5,000231
B—	1,111231
C—	.055LR
D—	14.5102
E—	130.5102
F—	1,305102
G—	750,000102
H—	200,000102
I—	45,000102
J—	394.5102
K—	4.93102
L—	.493102
M—	11,111102
N—	105,000102
O—	4,950102

List of Parts

One Weston model 301 Universal meter;
 Two Eby Commander binding posts;
 One Yaxley jack-switch No. 720;
 Three Yaxley jack-switches No. 763;
 One Yaxley push-button No. 2001;
 Two Yaxley push-buttons No. 2004;
 Three Yaxley push-buttons No. 2006;
 One Burgess Unicel flashlight battery No. 2;
 One Shallcross carrying case;
 One Shallcross type No. 610 engraved panel;
 One Shallcross No. 610 resistor kit, mounted on bakelite sub-panel.

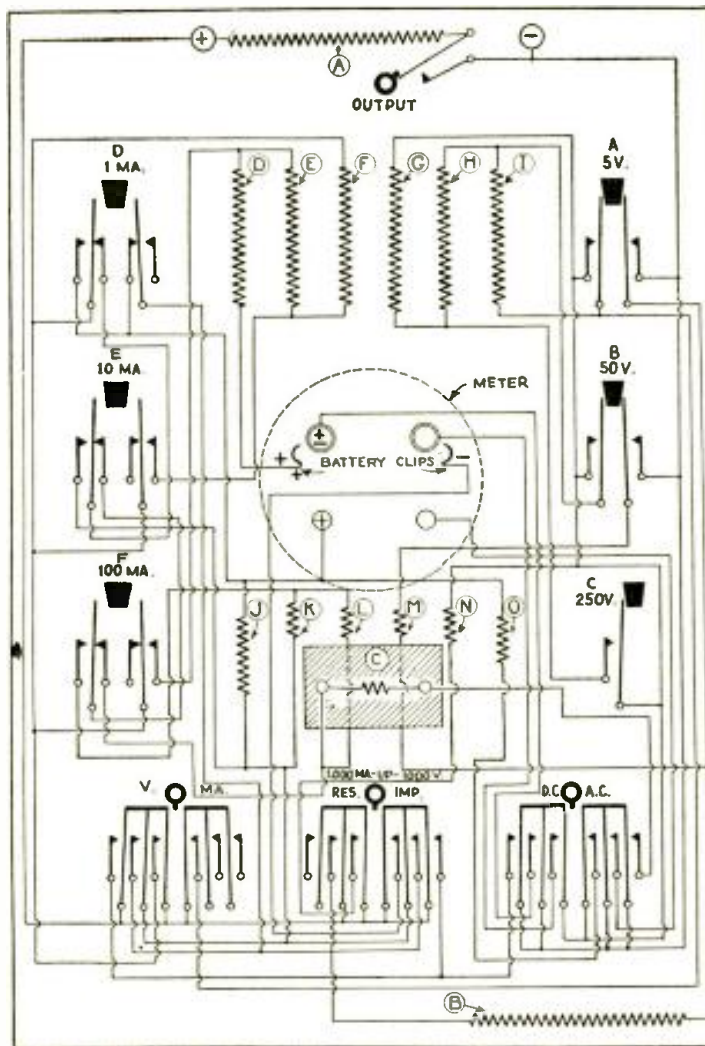

Fig. 1

Complete schematic circuit of the tester. The buttons to the left are for current, and those to the right are for voltage. The resistors necessary are labeled A, B, etc., and their values are given in the List of Parts.

as at this setting the instrument has a resistance of 5,000 ohms. Leave the output-meter switch turned to the right.

However, as the resistance of the meter is high compared to 5,000 ohms for the 50- and 250-volt ranges, both of which may ordinarily be used, a shunt resistor of 5,000 ohms is placed across the terminal of the instrument when the output-meter switch is turned to the "down" position.

CONSTRUCTING ADAPTERS FOR

F. L. SPRAYBERRY*

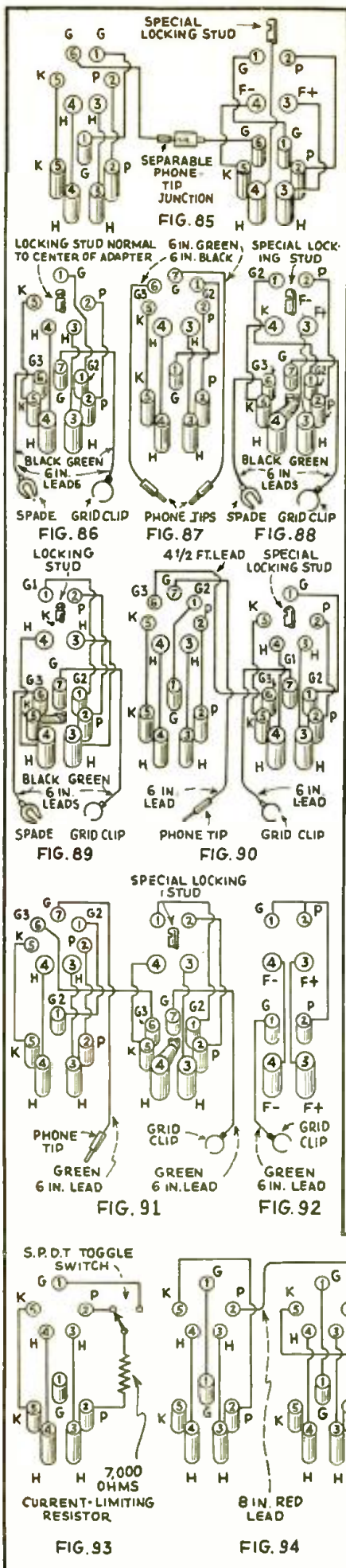

WHY YOU SHOULD USE ADAPTERS

● THOUSANDS upon thousands of tube testers and set analyzers have been sold to Service Men prior to the announcement of the six- and seven-prong tubes. To discard such instruments, merely because they do not test some of the latest tubes, is unwise from both an economical and technical standpoint. For this reason, RADIO-CRAFT has printed in the October and November issues diagrams and descriptions of adapters suitable for testing all the latest tubes. When the series is completed, adapters designed for all of the well-known makes of testers will be described.

THIS is the fourth installment on adapters suitable for all well-known types of analyzers. This series started with the October issue of this magazine and continued successively each month. This represents the final installment. As additional material is compiled, it will be printed. We continue with a discussion of adapters suitable for Supreme analyzers, and proceed with a description of those suitable for use with Hickok, Dayrad, Readrite, and miscellaneous test equipment.

No. 965DD, Fig. 63, enables analysis of the 6 prong tube circuits to be made with models 99A and 400A.

No. 965DS1W, Fig. 84, enables analysis of the above 6 prong tube circuits to be made with models 99A+ and 400A+.

No. 964DS1W, Fig. 85, is used with model 400B to analyze the circuits of all the 6-prong tubes.

No. 955DPP, Fig. 46, is used to get direct reading measurements of the first section of triple-twin tube circuits

*Service Consultant, National Radio Institute.

with models AAA-1, 90-1J, 2J, 3J, 4J, and 5J series, 99A+, 400A+, 400B and 400B-N4 series.

No. 944LS, Fig. 44, enables any Supreme UX analyzer socket to receive an overhead heater type of tube with provision for lighting the tube. This adapter is a companion adapter to the No. 949K.

No. 957SSLL, Fig. 86, is attached to the analyzer plug of Supreme model AAA-1 for analyzing 7-prong tube circuits, when used with adapter No. 975SLGL.

No. 975SLGL, Fig. 87, is used in the AAA1, 90-1J, 2J, 3J, 4J, and 5J series, and in the 400B-N4 series analyzer UY sockets to receive the 7-prong tube.

No. 947S1HL, Fig. 88, is used with model 90-1J and 2J series, and 400B-N4 series to make analysis of 7-prong tube circuits, when used with the No. 975SLGL.

No. 947SSLL, Fig. 89, is used with model 90-3J, 4J, and 5J analyzers for making analysis of the 7-prong tube circuits, when used with the No. 975SLGL.

No. 975DD, Fig. 49, is a twin adapter to be used with model 99A and 400A analyzers for analysis of 7-prong tube circuits.

No. 975DS1W, Fig. 90, is also a twin adapter for use with models 99A+ and 400A+ for 7-prong circuit analysis.

No. 974DS1W, Fig. 91, is a twin adapter for use with model 400B for analyzing the circuits of 7-prong tubes.

No. 968R, Fig. 54, is used with Supreme models AAA1, 19, 40 and 400 series to check the WD-11 tube in the 26 socket. Provision is made in this adapter for reducing the 1.5 volts to

This, the final article by Mr. Sprayberry, describes in detail adapters for Hickok, Dayrad and Readrite equipment.

TEST EQUIPMENT

1.1.

No. 944R1, Fig. 55, is used with the above Supreme models for checking the 864 tube in the '26 socket.

No. 972R1, Fig. 56, is used to check the Western Electric 215A tube in any Supreme tube checker.

No. 944GL, Fig. 92, checks the '32 and '34 tubes in the '26 socket of the 400 series of Supreme Diagonometer.

No. 954KPC, Fig. 15, is used on models 19 and 400 for checking the '33 tube in the '26 socket. This adapter also checks the 46, '47 and PZ tubes in the '45 socket and the GA and LA tube in the '71 socket.

No. 982, Fig. 12, is used in all models of Supreme tube checkers for testing the 82 tube in the '45 socket and the 83 tube in the '71 socket.

No. 944PLCR, Fig. 24, is used to check the 866 in the UX socket of any Supreme tube checker. This adapter should be used hastily since the 866 tube draws 5 amperes of filament current, which is a heavy load on the checker filament transformer.

No. 954SGL, Fig. 68, tests '24, '35 and '51 tubes in the UY checking socket of Supreme 400 Diagonometers and the '36, '38, '39, 44, '64, 65 and 68 tubes in the '71 socket of models 19 and 400.

No. 955SG-2, Fig. 93, checks each diode section of the G-2-S duo-diode tube when placed in the '27-checker socket of any Supreme tube checker. See Fig. 93.

No. 955GGKL, Fig. 48, is used in the '27 socket of Supreme checkers to test the 5-prong Wunderlich tube.

No. 964KGG, Fig. 59, checks the 6-prong Wunderlich tubes and the 29 and 69 tubes in Supreme model 17 and 19 tube checkers.

No. 965KPGL, Fig. 67, is used with

the 400 series Diagonometer in the '27 socket to check the 57 and 58 tubes.

No. 429, Fig. 40, is used to check the UV-199 tube in the UX socket of any Supreme checker.

No. 944GL, Fig. 42, checks the '22 tube in Supreme 400 series when placed in the UX socket with proper filament voltage.

No. 979WE, Fig. 57, is used with Supreme models AAA-1, 40 and 400 series to check the Western Electric 205D tube. This adapter, when used with a No. 954, can also check the 205D tube in the Model 19 checker.

No. 967, Fig. 43, checks the tubes with the UV base in Supreme tube checkers.

No. 944JY, Fig. 13, when used with model 400 Diagonometer tests the second plate of the '80 tube.

No. 982, Fig. 12, checks the 82 in the '45 socket of any Supreme tube checker and the 83 in the '71 socket.

No. 954, Fig. 58, checks the '37 and 67 tubes in a '01A socket of any Supreme checker.

No. 964KSP, Fig. 60, checks the 41, 42, PA and PZH tubes in the '71 socket of model 19.

No. 965KS, Fig. 16, also checks the 89 tube in models AAA-1 and 40.

No. 964KSH, Fig. 61, checks the 89 tube in model 19.

No. 965KPGL, Fig. 67, checks the 89 tube in the 400 series Diagonometer.

No. 944GL, Fig. 92, checks the 865 tube in the '10 socket of models 19 and 400 series.

Na-Ald Adapters for Hickok Testers

No. 949K, Fig. 4, is for testing Kellogg tubes with models SG4600, SG4700 and Statiktester. It is to be attached to the test plug.

(Continued on page 443)

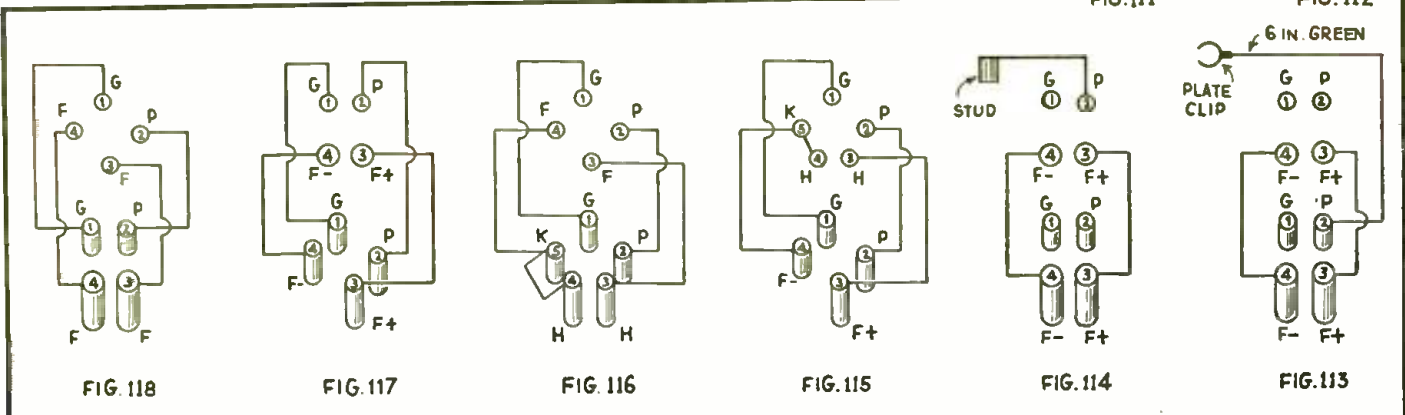
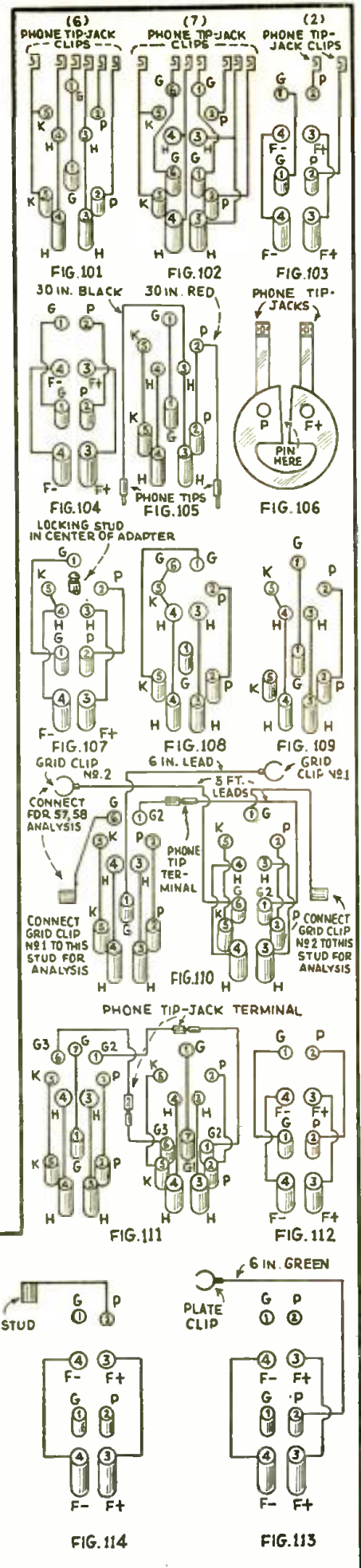

SERVICING RECEIVERS BY THE RESISTANCE METHOD

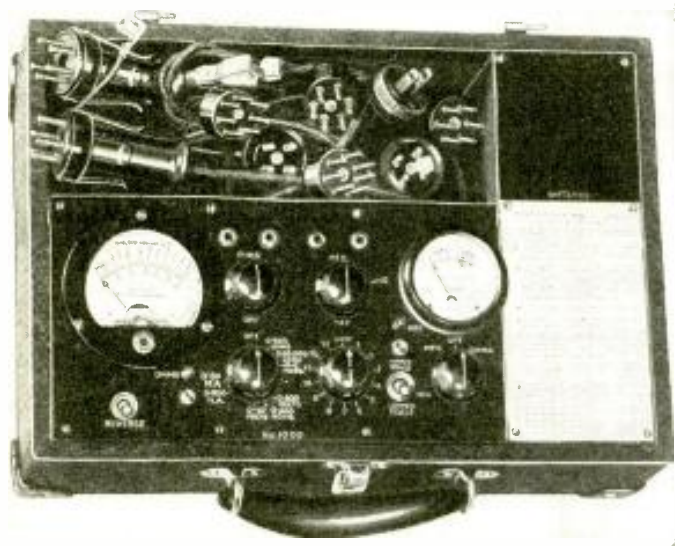
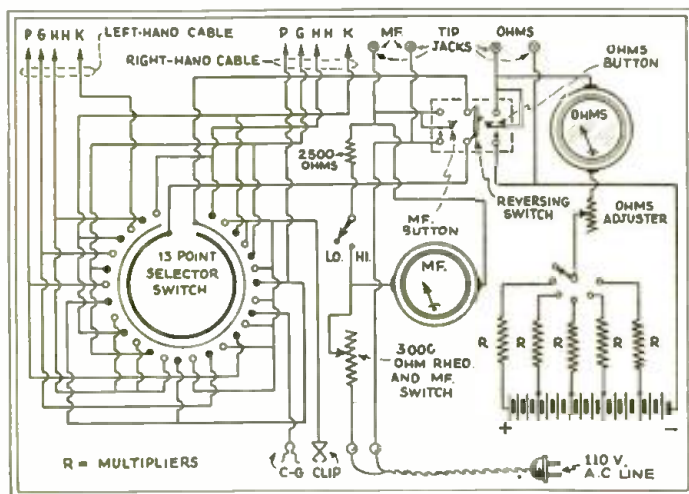

Fig. A
External view of the Readrite Model 1000 tester, used by the author.



Schematic circuit of the analyzer pictured above.

E VOLUTION of servicing methods, through actual practice upon modern radio receivers, has resulted in the development of "Resistance Measurement" as a means of rapid and efficient servicing. This method of analyzing and locating receiver troubles has many advantages over the better known form of "voltage measurement." One of the most important of these is the fact that in most cases, resistance measurement permits the Service Man to make his complete analysis and locate the trouble merely by inserting test plugs in the receiver tube sockets, without removing the chassis from its cabinet. This not only saves time, but also simplifies the problem of estimating cost of repair—a matter of considerable importance from the set owner's viewpoint.

Resistance measurements are far more specific than voltage measurements in the information they convey to the Service Man. This is because the former permit the complete isolation of each individual unit in the radio receiver, whereas the latter deal with complete circuits, usually involving a number of complex units.

An exceptionally practical description of the proper procedure to follow in using the new resistance method of servicing radio receivers.

H. G. CISIN, M. E.

When it comes to tabulating readings, resistance measurements are vastly more informative, not only where wiring diagrams are available, but even where the work must be performed without such diagrams.

In many types of modern radio receivers, voltage measurements are apt to be misleading. This applies to sets using class "B" amplification, resistance coupled amplifiers, etc.

Detector voltage readings are often worthless, especially in sets using the 55 tube and also in receivers incorporating automatic volume control. Most receivers have resistors in series with the screens. And here again, voltage readings cannot present an accurate picture of receiver conditions.

To sum up the comparison between resistance and voltage measurements, the former is superior because it is more systematic, more informative, more efficient and because it can be made with greater ease and rapidity.

The last part of this statement is predicated, however, upon the use of a properly designed set tester. In other words, in order to take the fullest advantage of the possibilities inherent in the modern method of resistance measurement as applied to servicing, it is necessary to employ a set tester built around an elaborate ohmmeter and including in its design, a capacity tester, a D.C. voltmeter and milliammeter and also a means of checking A.C. line voltage. Furthermore, such an instrument must be provided with suitable cables and plugs for making the necessary tests and for gaining access to all circuits from the various tube sockets.

All these important and exclusive features are an integral part of the new Readrite Resistance-Continuity and Capacity Tester. In addition, they are supplemented in this instrument by several other equally noteworthy characteristics. Thus, a thirteen point selector switch permits one to take as many as thirteen different resistance readings, if necessary, without making any changes whatsoever in the connections between the tester and the radio receiver, which results in remarkable rapidity in completing a check-up. The various resistance scales (0- 500 ohms; 0- 50,000 ohms; 0- 3,000,000; 0- 6,000,000 ohms) are available through another convenient selector switch. Voltages are readable on the same D.C. meter and three positions on the thirteen point selector switch may be used to obtain plate, grid, and screen-grid voltages at any socket. Jacks are also available, which permit the tester to be used independently of plug and cable connections, to measure resistances, voltages, and capacities.

Like any other method of circuit analysis, servicing by the resistance measurement method, involves not only a suitable tester, but also a reasonable degree of knowledge of certain fundamental principles plus actual practical experience. Unlike certain other methods, however, the knowledge needed is readily acquired and it goes without saying that practice soon leads to perfection.

Those who are just starting to employ resistance meas-

Blowtorch-ing Tubes to Life

Glenn Ellsworth

IN THE April, 1930, issue of RADIO-CRAFT appeared an interesting article by George Stoneham regarding a baking process in bringing back to a semblance of activity those tubes which have tungsten filaments.

Mr. Stoneham used a reflector set over an electric heater, in his experiments. In all probability the results obtained are the same as those secured by the author; however, there are a few drawbacks to the method described by Mr. Stoneham.

Many service departments are fairly busy, even with the so-called depression at its height and, what with trying to do several men's work, the shop technician is inclined to forget that he has one or more tubes in the cooker. The continued heat of the electric stove will melt the cement which holds the glass to the base and while the cement no doubt will harden again as the tube cools, the cement crystallizes, with the result that a slight strain will break it. Another drawback of the baking process is that the tube cannot be watched during the operation.

A description of the procedure and results of experiments in our shop, with all the later tube models, both heater and filament types, may be of interest to other radio men.

After having recorded the tube characteristics, subject the tube to the slow heat of a blowtorch, as shown in Fig. 1. (The torch illustrated is a Ratco part No. 4061; the 4 in. flame will reach a heat of over 2,000 deg. F.) Hold the tube two or three inches from the point of the flame and revolve the tube slowly.

Bring the "patient" closer and closer to the flame, until the flame comes in contact with the glass, and keep the tube in this position until the silvery deposit on the interior of the glass envelope has been driven off.

The operator will notice that within a second or two from the time of contact with the flame a round spot which is clear of the deposit will appear inside the tube; the best results will be secured by following the deposit with the flame and driving it from the glass of the tube itself. Finally, place the tube in a location where it may be permitted to cool *slowly* and without chilling.

The cooling process finished, place the tube in the tester and compare the present readings with those taken before the operation; then put them in a set and compare the performance with that of a "known" new tube. The results will be very gratifying; in fact, this procedure may even be tried on a new tube that does not quite come up to standards of an individual service department, with surprising results.

This reactivation process has been applied to the following tube types: the '24, '30, '31, '27, '26, '71, '45, '47 and '51. In fact, we are using in a short-wave receiver a set of '30's, '31's and a '32 which had been thrown into the junk box as of no further use but which, when reactivated by the blowtorch method, came to life in great shape and are still doing service comparable with that of new tubes, after seven months of continued use.

Our best results were obtained from tubes that showed a heavy deposit on the inside of the glass, while tubes having very little of the deposit generally did not react to the treatment. The proportion of cures to incurables is about 80%; about 20% were quite beyond recall from the limbo of defunct "valves."

It has been brought to the attention of the writer that one experimenter has found that the glass may melt when using the baking process; probably the tubes were exposed to a temperature greater than 3,700 deg. F. In using the torch, the tube is constantly under the eye of the attendant and as soon as the deposit leaves the surface of the glass, the flame is directed to another portion of the envelope.

This same technician has reported that tube noise had increased after reactivation. The chances are that noise would have been experienced anyway, due to looseness of the elements which will be found at times even in some of the best known brands, however, we have not found any trouble in this respect.

In our service work we have picked up a goodly number of extra dollars by availing ourselves of this "kink." A nominal fee of 35c per tube is charged and the customer figures that we are pretty good Service Men to do business with, since we have not stuck him for the price of new tubes;

also, he figures that we must know "our stuff" to be able to offer him this unusual service, and he passes the good word along to his friends. Of course, it is not advisable to discourage potential sales of new tubes, but this stunt is a mighty handy "ace" for use in many instances where time, money or some other factor is of importance.

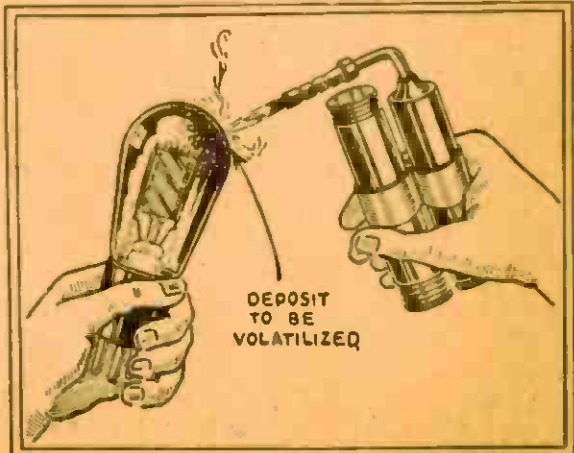

Figure 1

Noise-Reducing Antenna Systems

L. W. Van Slyck

THERE are several noise-reducing antenna systems now on the market, and with an idea to determine the effectiveness of the several types the following experiments were conducted.

An aerial 100 ft. long and 6 ft. high was erected, and to it was connected the various lead-in systems under test. At the other end of the lead-in system was connected, to the particular lead-in under test, a very sensitive radio receiver equipped with an output meter. The results obtained with systems A to C shown by diagram in Fig. 1, are shown graphically in Fig. 2; systems D and E reduced sensitivity to such an extent that they were discarded, and not recorded on the graphs.

System A, using an ordinary lead-in in the conventional manner, was used as the basis of comparison. System C used an antenna coupling transformer L1 consisted of 150 T. of No. 30 D. C. C. wire scramble-wound on a core 1/2-in. square, and tapped at the 25th turn. The inside lead was grounded and the outside end connected to the aerial; the tap went to the shielded lead-in wire. The width of the completed winding was 1/4-in.) The set transformer, L2, was identical, except that C1, 250 mmf. was placed in series with the shielded lead to the antenna post of the set. The coils were imbedded in paraffin in large-size salt shakers used as shield cans.

System B used a winding identical to the description above, except that a tap was not taken from the winding; instead, a 34-turn coil, center-tapped, was wound over the larger coil.

From the curves, it appears that system C is decidedly superior to any of the others tried, both from the standpoint of sensitivity and shielding efficiency. Incidentally, single-conductor shielded lead-in wire is less costly than the twin-conductor. Further, the transformers, tapped as shown, are simpler to construct than the type required in system B.

In measuring the relative sensitivity of the various systems, a shielded oscillator was coupled to the far end of the aerial proper by running a wire from the oscillator to an insulator hanging from the aerial wire. In measuring relative shielding efficiency the aerial was disconnected entirely, and the modulated oscillator was coupled to the various lead-ins by twisting 3 ft. of wire the same number of twists around the center of the lead-in wire, 50 ft. from the radio set and 50 ft. from L1.

As a further check on the comparative efficiency of the systems, the receiver was tuned to station WEBC (which is received at fair daytime volume) and starting a vacuum cleaner 20 ft. from the set and 25 ft. from the antenna, as a source of man-made static; the station program became unintelligible, using antenna system A. It was still unsatisfactory using system B. However, using system C, the local interference was hardly noticeable and this small amount was attributed to undue, abnormal coupling from the light-line into the lead-in. If the aerial was disconnected entirely, only the lead-in being used as pick-up, WEBC could be heard with fair volume at full set sensitivity, using system B, but WEBC was barely audible using system C.

Substituting an unshielded wire for the 4 in. length of shielded wire from 12 to the set, WEBC could be received with fair volume using system C, but with greatly increased noise pick-up (thus indicating the need for complete shielding; also, good grounds and circuit connections).

Finally, try to locate an interference-free position for the antenna; otherwise, it will not be possible to obtain the advantages offered by the improved lead-in system. In almost every location the direction straight up is relatively noise free, and, the higher the aerial the better the results. Unshielded receivers will tend to nullify the benefits of the antenna system,

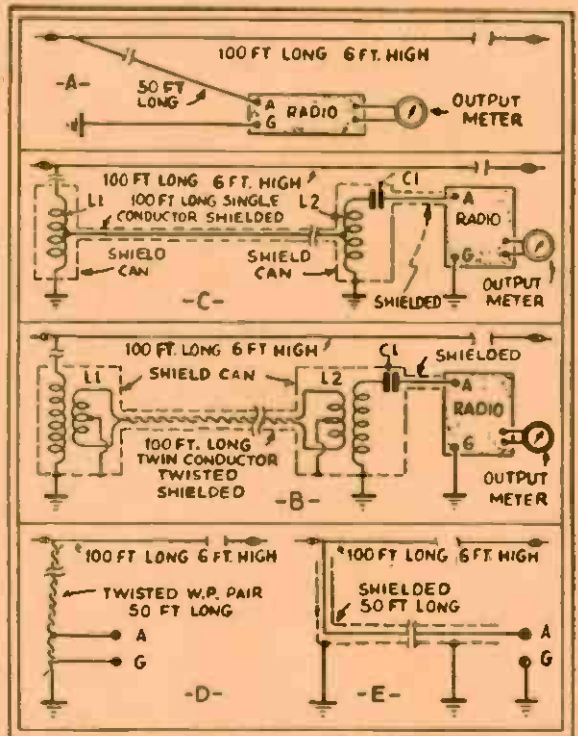

Figure 1

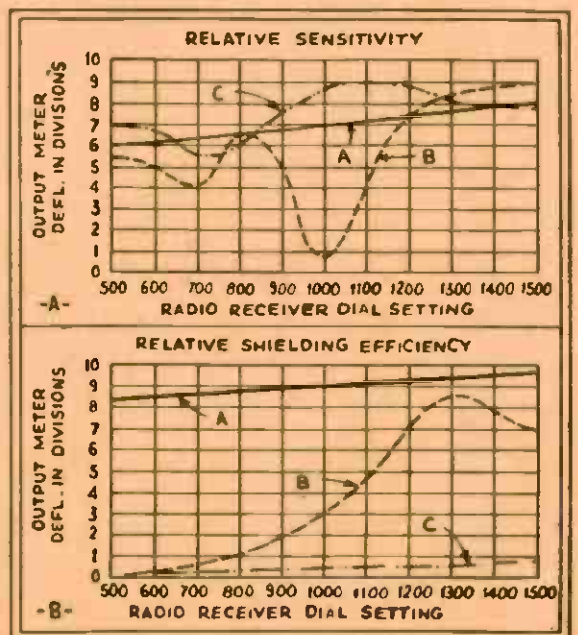

Figure 2

WHY YOU SHOULD SERVICE BY THE RESISTANCE METHOD

● THE resistance method of servicing entirely eliminates the guess work involved in voltage measurement. It localizes defective units instantly. The results are entirely

independent of cheap meters, power-supply conditions, poor tubes, and inaccurate estimation. Read this article now! It is meaty and has real practical information.

urement in actual radio servicing will do well to brush up on Ohm's law, and on the subject of resistors in series and parallel. The reading of a good book on the subject of resistance measurement as applied to servicing will furnish a firm groundwork for a complete and rapid mastery of the entire method.

Since fundamental principles are beyond the scope of this article, we will proceed to illustrate actual methods by performing a routine test on an RCA Victor, Radiola "Superette" model R7 superheterodyne. The new Readrite No. 1000 Resistance-Continuity and Capacity Tester was used to make this test which will be fully described below.

Before starting, there are a few points regarding resistance measurement which should be cleared up. First of all, it is desirable, in fact essential, that the condition of all tubes should be checked in a suitable tube checker. It is preferable that the tube checker be independent of the tester for a number of obvious reasons, which include ease and speed of testing, accuracy, etc. Secondly, it should be definitely understood that the resistance measurement system of servicing may need to be supplemented under certain conditions by voltage measurements. Furthermore, a routine check of condenser connections is obviously necessary, since an open-circuited bypass condenser will not necessarily change a resistance value. On the other hand, a shorted condenser may cause variation in resistance readings at a number of different points. Knowing that bypass condensers are not shorted, it is possible to diagnose the resistance readings more rapidly and more accurately.

Testing by the Resistance Method

Getting back to the test on the "Superette," the first step is to remove all tubes from their sockets and to disconnect the set from the A.C. supply. The condensers in the radio set are discharged by connecting a wire between the rectifier tube filament and the chassis. Then, the left-hand cable plug of the No. 1000 Tester is inserted in the rectifier tube socket. It is necessary, in this case, to utilize the five-to-four prong adapter. The right-hand cable plug of the tester is next placed in the first R.F. socket, VI. (See schematic diagram, Fig. 1).

The black wire is clipped on the set chassis, while the red wire is connected to the control-grid lead of the radio

set. Next, the selector switch located directly underneath the capacity meter is placed in the OHMS position. See Fig. A.

The selector switch on the right-hand side of the tester is now turned to the No. 1 position. In this position, it measures the resistance from the heater to the chassis, which in this case, is found to be 10 ohms. This measurement is made with the left-hand selector switch on the 0—500-ohm scale. The ohmmeter is adjusted to full scale before the reading is taken, by holding down the button marked OHMS and rotating the knob marked OHMS, until the needle shows full-scale deflection, which is zero ohms.

The button is then released and the reading on the ohmmeter for the 0—500 ohm scale is correct.

The right-hand selector switch is next turned to the No. 2 position. This measures the resistance between the cathode and the chassis. Since this includes fixed resistor R2 and volume control R1, it is obviously necessary to use a larger resistance scale. Accordingly, the selector switch at the left, is turned to the 0—50,000-ohm scale and the ohmmeter is again adjusted to full scale deflection, using the push-button and the knob marked OHMS, as explained above. This procedure must be followed each time the position of the scale selector switch is changed. With the volume control all "in," the resistance is found to be

3,950 ohms. With the volume control adjusted for maximum volume, the total resistance is that of R2 only, or 150 ohms. If the bypass condenser C7 had been shorted, the resistance reading would have been zero instead of 150 or 3,950.

Turning the selector switch to position No. 3, we obtain the resistance measurement between the screen grid (grid at socket) and the chassis. This includes R4, R2 and R1, totalling 8,150 ohms, when the volume control is set at maximum.

At position No. 4, the resistance from plate to chassis is measured. This includes the resistance of the R.F. primary, 58 ohms, plus resistors R3, R4, R1 and R2, totalling 26,308 ohms with the volume control all the way in, and 22,508 ohms, with the control set for maximum volume.

Position No. 5 is used to measure the resistance from the control grid to the chassis. This is 5 ohms, the resistance of the secondary of the antenna coupler.

(Continued on page 427)

TABLE No. 1		
R.F. Transformer Primaries	5	to 75 ohms
R.F. Transformer Secondaries	.5	to 5 ohms
I.F. Transformer Primaries	25	to 200 ohms
I.F. Transformer Secondaries	25	to 200 ohms
A.F. Transformer Primaries	500	to 3000 ohms*
A.F. Transformer Secondaries	1100	to 8000 ohms*
Output Transformer Primaries	300	to 1100 ohms*
Output Transformer Secondaries	.2	to 10 ohms*
Power Transformer Plate Windings	200	to 900 ohms**
Power Transformer Primaries	1	to 18 ohms
Power Peak Filter Chokes	150	to 800 ohms
Speaker Field Windings	800	to 2500 ohms
R.F. Chokes	10	to 150 ohms
A.F. Chokes	100	to 1000 ohms

* May be total resistance of split winding or resistance of each half.
** In the majority of instances, this value represents the total resistance of rectifier plate winding.

A very useful chart showing the values of commonly used units. Courtesy of the author, John F. Rider, "Servicing Receivers by Means of Resistance Measurements."

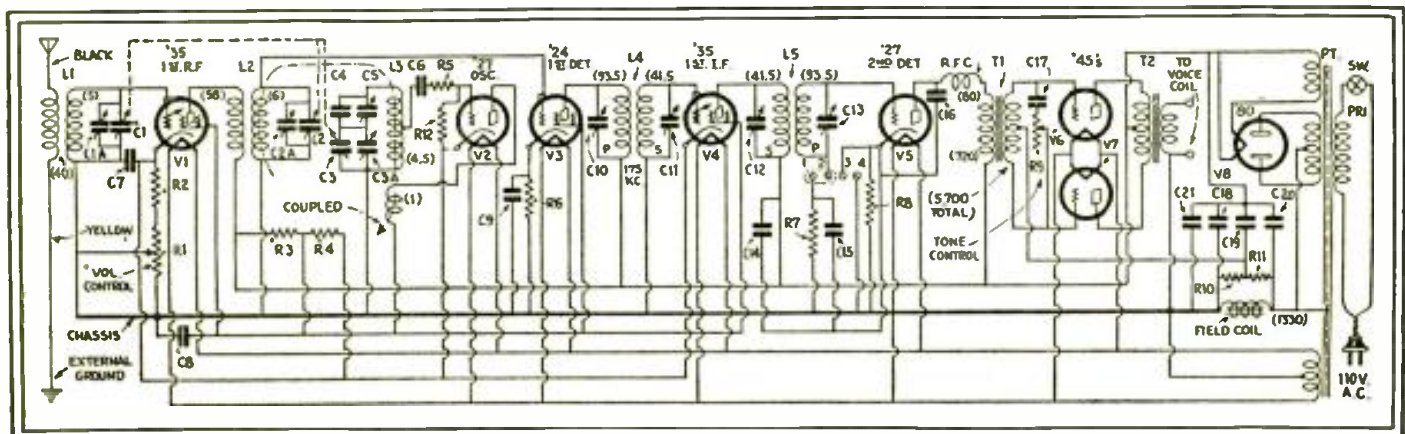

Fig. 1
Schematic circuit of the Radiola Superette Model R7, analyzed by the author.

Do you know what the new "aerial-formers" do?
 Do you know how they actually function?
 Do you know how they reduce man-made static?
 Do you know whether one or two are required?
 If not, read this interesting article now!

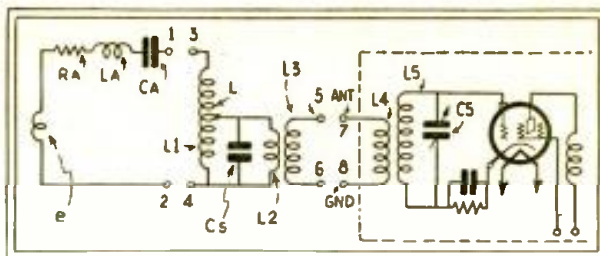

Fig. 1
 Schematic circuit illustrating the relation of the antenna, aerial transformer, and radio set.

REDUCING MAN-MADE STATIC

GLENN H. BROWNING

OWNERS of radio sets the country over have asked their local experts and others versed in the radio art, time and time again, what can I do to keep the "clicks" and noise from spoiling reception? The source of most of these complaints, were the truth known, is radiation or conduction of electrical disturbances from everyday appliances. Many motors, thermostatic devices, therapeutic machines, and a host of others create disturbances or transmit a disturbance back into the 110-volt lighting circuit which is picked up by the radio set and emitted from the loudspeaker as noise.

In spite of the fact that broadcasting stations are constantly increasing their power, it is claimed by those making a study of the problem that the ratio of noise to signal is, in a great majority of congested districts, increasing at an alarming rate. This is probably due to the fact that more electrical appliances are being operated. However, it must be said in all fairness to the manufacturers of such apparatus that they have sensed the problem and that many of them are incorporating filterizing apparatus of such a nature that the interference created within the appliance is suppressed. Numerous interesting cases might be cited where a manufacturer had neglected this detail, and as a consequence some of his best distributors told him that unless he reduced or eliminated the radio interference, they could not afford to handle that particular merchandise.

Of course, some disturbances originate in defective equipment belonging to the public service corporations. However, transformers, insulators, etc., are many times blamed by the radio public when they are entirely innocent. Because of frequent calls for relief from interference, many of the power companies have created a department whose duty it is to locate the source of the disturbance. If this turns out to be faulty equipment it is immediately repaired or replaced. However, if the source is an appliance, the power company representative can only make recommendations as to the appropriate filter to apply. Thus the power com-

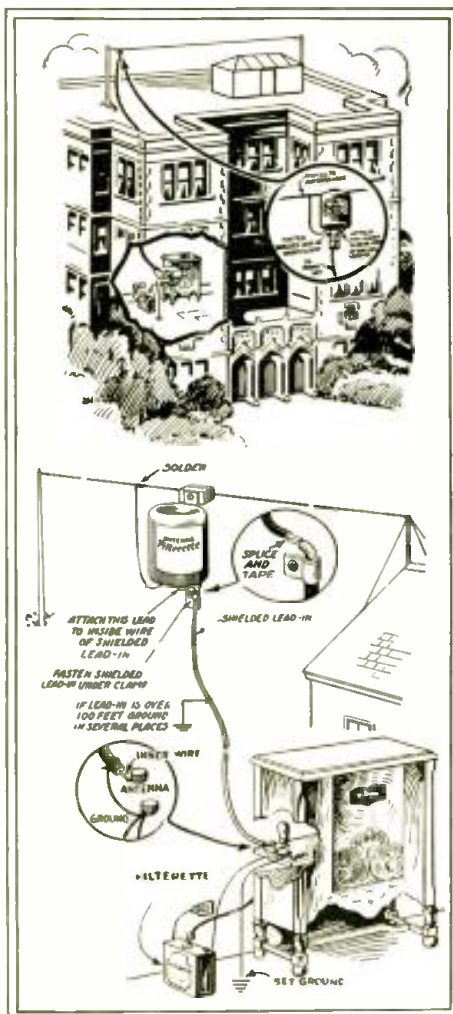

Above, the correct method of installing an aerial transformer.
 Below, details of a good installation.

pany has entered the first line trenches in combating man-made static. Their efforts are not entirely altruistic for if interference spoils programs, the

Mr. Browning, author of this interesting article, is well known to the thousands of radio fans who have constructed his famous Browning-Drake receivers. Being an authority on radio, it is with great satisfaction that we are able to present this instructive article.

listeners' retort is to turn off the set which, in turn, effects the power company directly.

Methods of Eliminating Noise

There are several methods of reducing or eliminating interference. The best and most far reaching is that of suppression at the source, for one piece of apparatus may be disturbing whole neighborhoods and a few dollars spent in filterizing will entirely eliminate the difficulty. The Tobe Deutschmann Corporation has made a study of interference for the last five years and has been instrumental in improving reception in thousands of communities through their development of Filterettes for application to noise sources. According to their experience, this has proved to be a most satisfactory method. However, there is always difficulty in locating the interfering device or devices, and in some cases the sources are so numerous as to present a real problem.

With this in view, they started to perfect a device which could be employed with the individual receiver. This has been accomplished in the development of the Filterizer Kit. If interference is present there are only three ways that it may enter the receiver. First, it may be picked up by

(Continued on page 436)

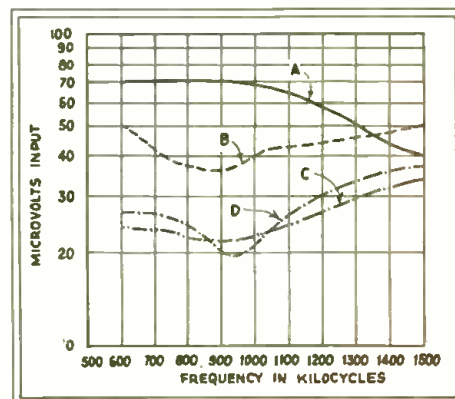

Fig. 2
 Curves illustrating the effect of the aerial transformer. Curve A represents the response of a set with low-impedance input; curve B, the same set with an aerial transformer. Curve C, a set with a high-impedance input; and D, the same set with an aerial transformer. The difference between A and B is marked; not so with C and D.

THE ANALYSIS OF RADIO RECEIVER SYMPTOMS OPERATING NOTES

CROSLY 54

Glenn Ellsworth

A VERY peculiar incident occurred while we were servicing one of the Crosley model 54 portables; during the routine of running through the set with the Jewell tester, we noticed the detector voltage of the plate circuit to be 90 V., while on going further with the tests, we found the voltage of the '45 power tube measured 350, with a grid bias of only slightly better than 12 V. (The circuit of this set is Fig. 1.)

We were surprised at the low reading obtained, for it has been our experience that a Service Man may be misled through what seems to be a false reading in this portion of the receiver, especially if the manufacturer is using some of the many forms of resistance-coupled amplification. However, the true reading may generally be found by using the test leads and the high-resistance meter of the analyzer, and taking the voltage reading between the chassis and filament of the power tube. Still, though, the grid voltage tested only about 15.

The peculiarity of the case was that the set would run along giving fair reception of the local broadcast stations when suddenly it would break into what resembled an audio-frequency howl such as is liable to occur if the set is not properly choked and bypassed; then, when we tried to test the set, the howl would stop and normal reception would be resumed.

We finally plugged the analyzer connection into the power tube socket in order to observe voltage variations as the set went into and out of oscillation. With a strong local station coming in

WHAT THIS DEPARTMENT IS FOR

It is conducted especially for the professional Service Man. In it will be found the most unusual troubles encountered in radio service work, written, in a practical manner, by Service Men for you.

Have you, as a professional man, encountered any unusual or interesting Service Kink that may help your fellow workers? If so, let us have them. They will be paid for, upon publication, at regular space rates.

and with the volume control retarded, we found a voltage of 300 on the plate of the power tube; the bias was slightly better than 12 V. When the circuit went into oscillation the plate voltage dropped to 175 and the control-grid bias went up to 55 V.

The receiver was checked thoroughly for leaky condensers, resin joints, in fact, everything we could think of that might have some bearing on the existing conditions, but without any noticeable improvement; even checking the resistors of the various circuits, in the belief that the ohmmeter would lead us to the cause of the trouble, did not prove anything except that as the resistors became warm they changed value to the extent of about 30 percent.

When the difference in the resistors was finally proved we replaced resistor R1, Fig. 1, with one from the Crosley stock; we could not replace the others

as these had not been received by the distributor and, consequently, we were forced to shunt resistor R2 with a stock Durham unit of 0.1-meg. This procedure raised the control-grid potential on the power tube to 55 V. and, with the Crosley replacement for R1 the plate voltage held steadily at 270 V. Although these readings are slightly higher than those listed in the service manual, this is accounted for in the maximum voltage of the Portland, Ore., mains which carry from 117 to 125 V., A.C. The analyzer readings correct for a 110 V. line are given below:

Tube	Fil.	Plate	C. G.	Screen-G.	Plate
'24 R.F.1	2.1	160	3.1	85	3 ma.
'24 R.F.2	2.1	160	3.1	85	3 ma.
'24 Det.	2.1	215	9.0	85	3 ma.
'45 Power	2.2	230	45.0	33 ma.
'80 Rect.	4.1	340	45 ma.

After these changes were made the tone quality and sensitivity were so greatly improved that the customer volunteered the information that, prior to this service work, he had been unable to "play" any of the more distant stations but that on the following evening he journeyed, via radio, as far east as Chicago, south to the capital of the Mexican republic, and picked up heretofore unheard intermediate stations.

RCA-VICTOR

Frank M. Davis

IN the model R-34, R-35, and RE-57 Victor receivers one of the weak spots is the 70,000-ohm resistor, in the plate circuit of the '27 first A.F. tube, which may open or change value. In this series of Victor sets the plate

(Continued on page 429)

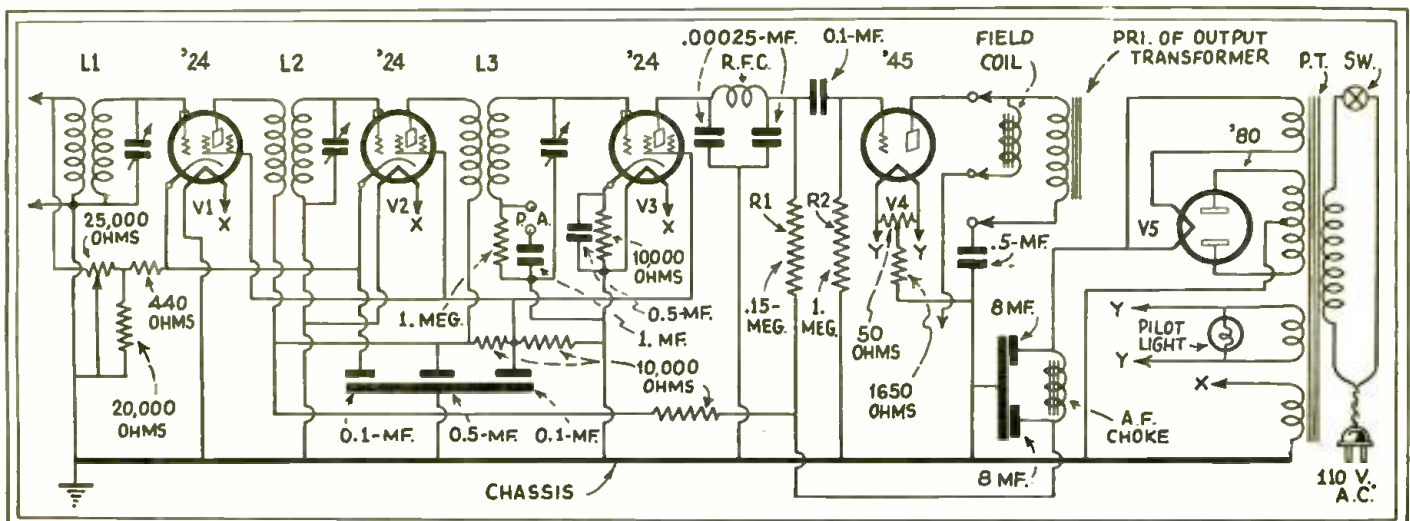

Fig. 1

Complete schematic circuit of the Crosley model 54 portable receiver. Resistor R1 was replaced and resistor R2 was shunted to obtain good results.

SHORT CUTS IN RADIO SERVICE

\$10 for Prize Service Wrinkles

Previous experience has indicated that many Service Men, during their daily work, have run across some very excellent Wrinkles, which would be of great interest to their fellow Service Men.

As an incentive toward obtaining information of this type, RADIO-CRAFT will pay \$10.00 to the Service Man submitting the best all-around Radio Service Wrinkle each month. All checks are mailed upon publication.

The judges are the editors of RADIO-CRAFT, and their decisions are final. No unused manuscripts can be returned.

Follow these simple rules: Write, or preferably type, on one side of the sheet, giving a clear description of the best Radio Service Wrinkle you know of. Simple sketches in free-hand are satisfactory, as long as they explain the idea. You may send in as many Wrinkles as you please. Everyone is eligible for the prize except employees of RADIO-CRAFT and their families.

The contest closes the 15th of every month, by which time all the Wrinkles must be received for the next month.

Send all contributions to the Editor, Service Wrinkles, c-o RADIO-CRAFT, 98 Park Place, New York City.

Prize Award

ODD VALUE RESISTORS

J. A. Cargile

JUST thought I would send you the dope on a wrinkle that has saved me a lot of time, worry, and probably money. I am not advertising for anybody, but I will have to thank Electrad for their voltage divider, and Federated Purchaser for their special 1mm. solder, which makes this trick possible. The result as indicated in Fig. 1 is a resistor of any odd value desired within the range of a few thousand ohms.

The resistance element of Electrad voltage dividers ordinarily is made from a piece of "wound" resistance wire of 50 to 100 watt rating. To get a unit of any desired value, unwind enough of the divider to obtain the required resistance, and then about 1/8-in. from the end bend over a soldering lug and clamp it around the resistor and complete the operation by unraveling a little of the fine resistance wire and soldering it to the lug by means of the 1 mm. solder. This operation is dupli-

cated at the other end of the resistance strip.

If the completed resistor is too long, wrap it around an ice pick, slip it off, and then stretch it to the desired length.

FINDING SHORTS BY LAMPLIGHT

Chas. A. Schuldt

FIND secondary "shorts" by removing all tubes and inserting a lamp in series with the primary and the 110 V. supply. Usually, the lamp will hardly glow unless there is a short, in which case the light will be relatively brilliant. This check is made after having tested the secondaries for continuity. The circuit is Fig. 2.

Shorted primary turns would show higher secondary voltages; and, of course, an open primary is easily discovered; this completes your transformer tests.

This method is more simple than keeping check records on the many types of transformers one might encounter in service as discussed by Mr. Wellman in the August, 1932 issue of RADIO-CRAFT, page 98.

6V. CAR RADIO SET ON 12V.

Erwin J. Schafer

NOT all automobiles are equipped with 6-volt storage batteries, consequently, the following manner in which the writer has adapted his Crosley "Roamio" Model 92 receiver to operate on a 12-volt filament supply may be of interest to other radio Service Men. By following the circuit arrangement of Fig. 3, the current which would normally be wasted in a bleeder resistor to compensate for the additional 6-volts is put to use. This is particularly advantageous since the 12-volt batteries are usually of about 40 ampere-hour rating and, consequently, discharge much more rapidly than the 6-volt type which, in the same service, will be rated at 80 ampere hours.

In the Crosley model 92 the '71A tube and speaker field together draw approximately 1.25 A.; the four '36's and the '37, about 1.20 A. The series parallel "A" circuit of Fig. 3 reduces the current consumption 50%. For a pilot light, use a regular 12 V. bulb. Meter readings indicate the following filament potentials: Type '36 and '37 tubes, 6.1 V.; Type '71A tube, 5 V.; Speaker field, 5.9 V.; Pilot light, 12 V. Dotted connections indicate the new wiring.

(Continued on page 430)

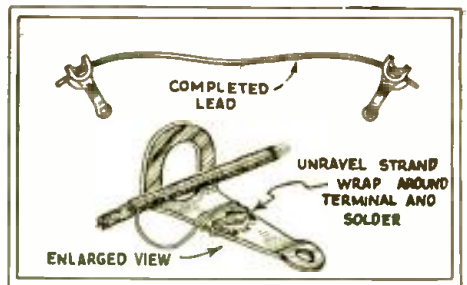

Fig. 1

This is an excellent idea for making meter shunts. It's a quick method, too.

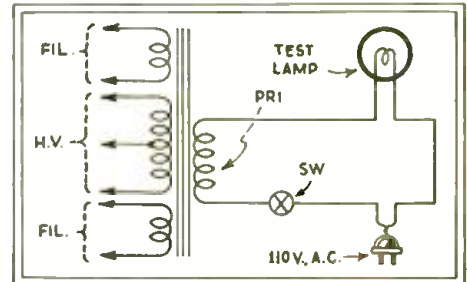

Fig. 2

This "short" locator is simple and fairly accurate. How about some of you using this with a photoelectric cell and amplifier?

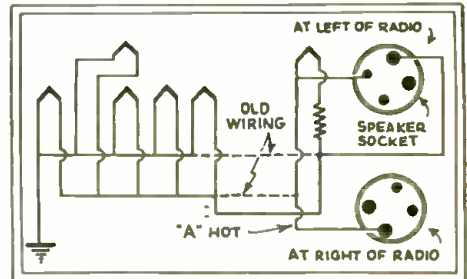

Fig. 3

Here's a nice way of using the 12-volt storage battery in the car. How about it, you Dodge owners?

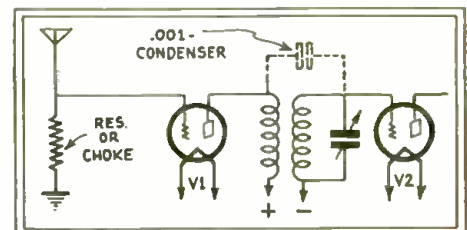

Fig. 4

Well, you theorists, explain this. And the author says it works, too!

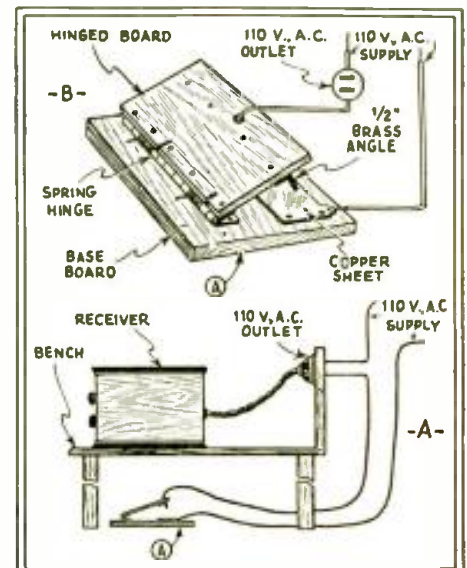

Fig. 5

We wonder whether this foot system is equipped with free wheeling?

SERVICING WITH AN OSCILLATOR

A description of a method of servicing in which the oscillator is the important item.

M. D. YANASKO

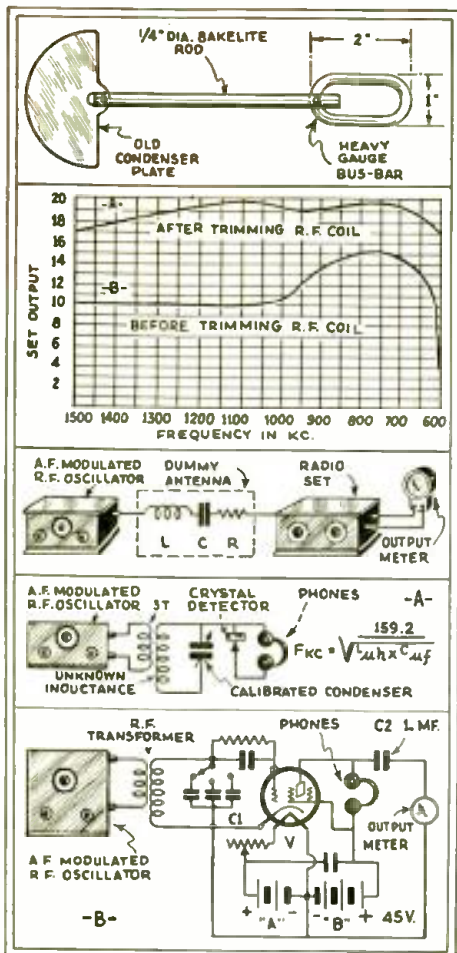

Fig. 1, top
Construction details of the aligning tool.

Fig. 2, second from top
Output of set before and after aligning.

Fig. 3, center
Connecting the dummy antenna to the set.

Fig. 4, lower
At A, circuit of a "uni-lateral" calibrating device;
at B, measuring the relative gain of tubes.

IT IS a surprising fact—but a true one—that there are many radio men who do not understand the use of a service oscillator. Most of these men think that an oscillator is useful only for aligning I.F. transformers. However, quite a little service work can be done with the aid of an A.F. or R.F. modulated-oscillator—work of a type that makes the superficially-trained Service Man almost believe in magic.

Let us relate, for instance, the story of an A.K. 40 receiver that had been "serviced" by four different Service Men, and still gave very mediocre performance. Every voltage test with the best analyzer showed everything O.K. Resistance and continuity tests upheld the analyzer results. That's the way things were until the fourth man was called in. He evidently was more intelligent or more experienced. He re-balanced the set and made an improvement. But still the set lacked sensitivity and would not separate certain local stations. This same man just about convinced the

owner that his set was "worn out" and never would be any better. Yet, after this set left our shop it not only separated the locals but actually was bringing in KFI at 9:30 P.M., and did so for a week while under test. From Pittsburgh to Los Angeles on a "worn out" set!

Here are just a few things that can be done with a service oscillator (remember that what applies to the 1,500-500 kc. band applies to the 200-100 kc. band): First, we can measure inductance and capacity of antennas; and of long speaker lines for the insertion of line filters. Second, we can measure the inductance of coils and condensers. The latter feature is especially valuable in servicing "orphan" radio sets for which parts are no longer made.

Servicing "Orphan" Sets

For instance, there was the case of the A.C. Dayton 66 which was shipped to a new location in a bus; the owner having left the tubes in the set. When the radio was turned on there was a puff of smoke and the receiver refused to work. A test showed a burned out R.F. '26, R.F. transformer secondary and R.F. filter choke. The '26 evidently was shorted. Replacing the choke was easily accomplished but a new coil had to be wound. The inductance of the other coil was measured with the aid of a service oscillator and a new coil was wound and matched to the condenser. According to the customer, the set worked as well after the servicing as it did before.

And then we can find mis-matched coils and condensers. This trouble we encountered in an A.K. 37, the tuning dial of which had wedged itself on the shaft and jammed against the case. It was wedged so tightly that it actually

had to be chiseled off. (The owner was a Photophone Service Man and he had attempted to repair his own set.) As a result of this chiseling the condenser shaft was bent and the rotor plates wobbled in an eccentric orbit. We straightened the shaft and re-balanced the set, but somehow it lacked pep. It was re-balanced and this operation showed that a coil and condenser did not match. We corrected this and the set was O. K.

The type of equipment used in this kind of service work is simplicity itself. It consists of an oscillator, an output meter and a vacuum-tube voltmeter. The voltmeter is useful but not essential, as much service work can be done with only an output meter and an oscillator.

Before considering a few ways in which to use the oscillator in service work, let us stress the point that, first of all, the set should *always* be analyzed, for high-frequency troubles are only a small percentage of the total causes for service. Under no circumstances touch the tuned circuits of a radio receiver unless, firstly, you are thoroughly familiar with the set and, secondly, have adequate equipment which you can operate correctly.

Using the Aligning Tool

Now, let us go back to the A.K. 40 with which we began this article. When the set was brought into the shop we analyzed it thoroughly. We tried balancing and made no improvement. Then the alignment of the tuned circuits was undertaken. The tester used and its constructional details are shown in Fig. 1. The set was tuned to a station and the flat ring was inserted inside the first coil (second R.F. stage). The volume decreased, showing that the coil inductance was normal or at least not too high. When the second coil was tested (third R.F. stage) the volume increased, which proved that the inductance of the coil was too high (since the ring causes a decrease in the effective coil inductance).

To correct this trouble, a piece of No. 18 aerial wire was wrapped around the outside of the coil and soldered to

THE R. F. OSCILLATOR REPLACES GUESS WORK

- Do you really know when tuning dials are out of line?
- Do you know when coils are too small or too large?
- Do you really know how to align R.F. circuits properly?
- Do you know how to use an oscillator properly?
- Would you like to know how to use one properly?

THEN READ THIS INTERESTING ARTICLE NOW!

PHILCO 4-TUBE SUPERHETERODYNE RECEIVER MODEL 80
PHILCO 5-TUBE SUPERHETERODYNE SET MODEL 37

(Model 80: A simplified 3-tube-and-rectifier superheterodyne incorporating a combination oscillator—first-detector, a second-detector, and an output pentode; dynamic reproducer.

Model 37: A battery-type 5-tube superheterodyne; band selector; class B power amplifier; magneto-dynamic reproducer.)

Model 80

This electric receiver is designed to give satisfactory reception within the limits of the set, at the lowest possible cost. Except for the rectifier, all the tubes are of the 6.3 V. filament type. Although this interesting set does not have any R.F. or I.F. amplification, it has a very selective circuit arrangement, due to the use of the superheterodyne circuit, which also provides even amplification over the broadcast band. The power consumption of this set is 46 watts.

Never connect the chassis to the power supply unless the reproducer and all the tubes are in place.

The following components are used in this receiver model: Condensers C1, C2, tuning condensers; C1A, C2A, R.F. trimmers; C3, padding condenser; C4, C5, I.F. trimmers; C6, regeneration condenser; C7, 710 mmf.; C8, C10, (in one unit) .09-mf.; C9, 50 mmf.; C11, .001-mf.; C12, .015-mf.; C13, .006-mf.; C14, 8 mf. (electrolytic); C15, C18, .01-mf.; C16, 4 mf. (electrolytic); C17, 10 mf. (dry electrolytic).

Resistor R1, 20,000 ohms; R2, R6, 10,000 ohms; R3, 9,000 ohms; R4, 16,000 ohms; R5, 4 meg.; R7, 1. meg.; R8, 0.24-meg.; R9, 0.49-meg.; R10, 325 ohms.

The following tube characteristic data is for a line potential of 115 V.: Filament potential, V1, V2, V3, 6.3 V.; V4, 5 V. Plate (to cathode) potential, V1, 245 V.; V2, 40 V.; V3, 240 V.; V4, 340 V. (per plate). Screen-grid (to cathode) potential, V1, 165 V.; V2, 15 V.; V3, 255 V. Control-grid (to cathode) potential,

V1, 6.4 V.; V2, 0.4-V.; V3, 4 V. Cathode (to filament) potential, V1, 8.4 V.; V2, V3, zero. These readings are obtained with the volume control at maximum and the station selector adjusted to the low-frequency end of the scale. (Readings taken with a radio set tester and plug-in adapter will not be satisfactory, state the manufacturers, it being necessary to use test products and a high-resistance meter.)

Facing the back of the chassis, the compensating condenser at the right (with the micarta hex-head nut) should be adjusted for maximum sensitivity at the time of installation. Tune in a station near the middle of the dial and adjust the hex-head nut until a swishing sound and circuit oscillation are heard when tuning in a program; then, adjust the nut 1/4-turn, counter-clockwise, beyond the point where these sounds stop. If these sounds can then be heard at other settings of the tuning dial, slightly advance the nut adjustment counter-clockwise. (Follow this procedure in the event that it becomes necessary to change the shielded type 36 tube.)

In chassis above No. 5, C13 connects as shown dotted; also, the hum-bucking coil is shorted out, and C17 (10 mf. electrolytic) is replaced by a unit of .015-mf., while C15 is eliminated.

Model 37

To meet the demand of the rural-ite who does not have the service of an electric light system from which to power his radio receiver, but who would like to have a set possessing the tone quality and selectivity of electric sets, and at low cost, this set has been developed.

Filament ballast V6 compensates for the variation in voltage output of the Philco Dry A battery for which this set has been designed; the "A" consumption is 720 ma. The "B" drain, from the 135 V. battery, varies between 6 and 12 ma., depending upon the strength of the signal; a class B or push-push output stage is used. The output tube is a special, new "class B" tube. The combination first-detector and oscillator is a new, special R.F. pentode.

Following are the characteristics of the components: Resistor R1A, R1B, 5,000 ohms, each; R2, 2,900 ohms; R3, 6,000 ohms; R4, R7, 1,000 ohms; R5, 51,000 ohms; R6, 25,000 ohms; R8, 99,000 ohms; R9, 0.1-meg.; R10, 90,000 ohms; R11, filament ballast; R12, 0.49-meg.; R13, 0.499-meg.

Condensers C1, C2, C3, tuning condensers; C1A, C2A, C3A, R.F. trimmers; C4, 710 mmf. padding condenser; C4A, pad trimmer; C5, C6, I.F. trimmers; C7, C8, 250 mmf.; C9, .01-mf.; C10, .002-mf.; C11, C17, 0.5-mf.; C12, .25-mf.; C13, C15, .05-mf.; C14, 0.1-mf.; C16, 710 mmf.; C18, 0.15-mf.

Following are the tube characteristics: Filament potential, V1 to V4, 1.9 V.; V5, 2 V. Plate (to cathode) potential, V1, 120 V.; V2, 120 V. (to filament); V3, 2 V. (to filament); V4, 110 V. (to filament); V5, 120 V. per plate. Screen-grid potential, V1, 60 V. (to cathode); V2, 60 V. (to filament); V3, 45 V. (to filament). Control-grid potential, V1, 2.5 V. (to cathode); V2, V3, 2.5 V. (to filament); V4, 0.4-V.; V5, 0.4-V. per grid. Cathode (to filament) potential, V1, 5.5 V.

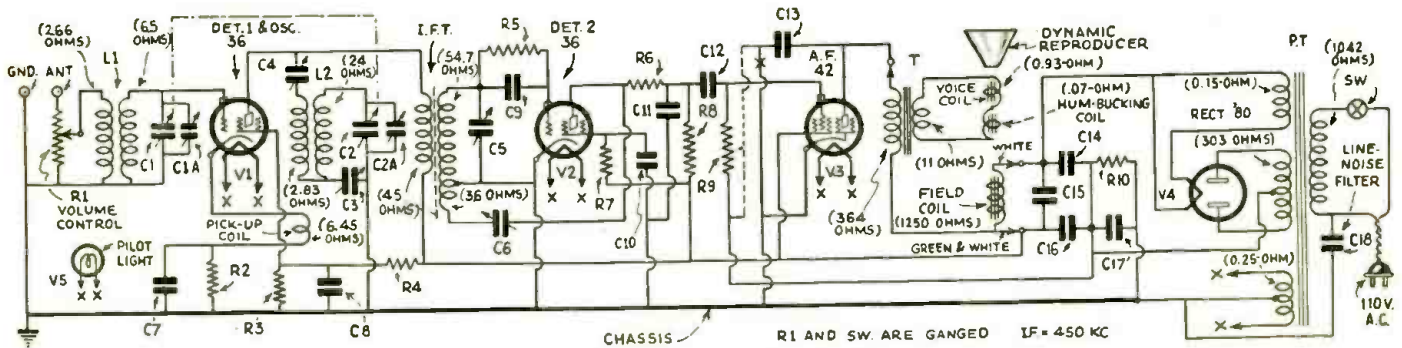

Schematic circuit of the Philco model 80 4-tube superheterodyne. A selective set with an output pentode and a dynamic reproducer.

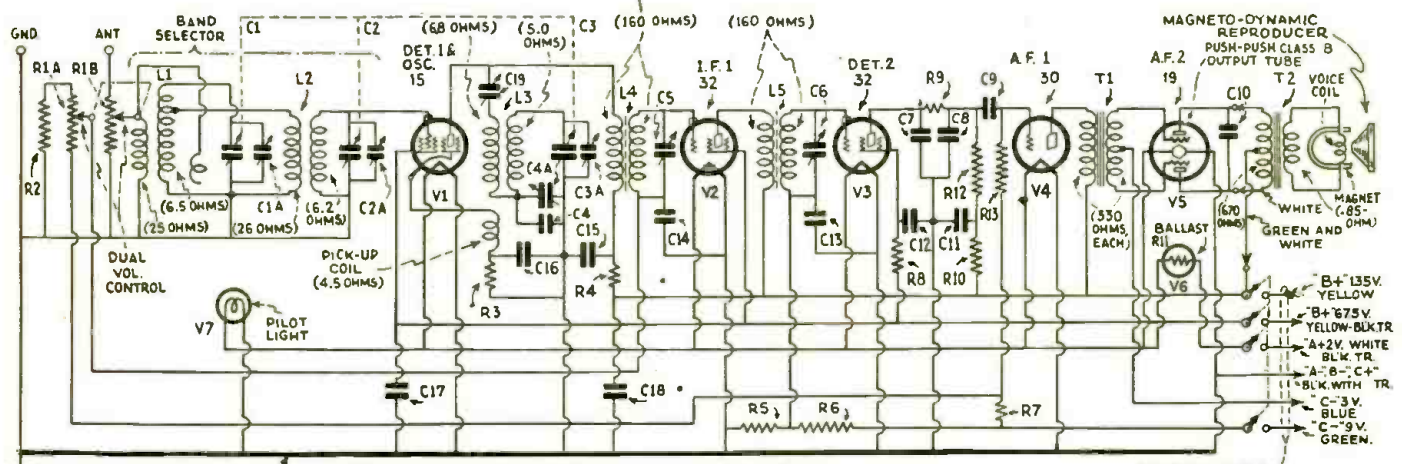

Schematic circuit of the Philco model 37 5-tube battery-type superheterodyne, incorporating a special oscillator-detector and Class B tube.

STEWART-WARNER, MODELS 50, 51 AND 58, "MAGIC DIAL" SERIES 105 CHASSIS 11-TUBE ALL-WAVE SUPERHETERODYNE

(Incorporates short- and broadcast-wavelength reception; local-distance switch; 33 and 78 r. p. m. phono.; dual reproducers; automatic volume control; tone control; push-pull pentodes; two-speed tuning.)

Latest in the Stewart-Warner line is the "Magic Dial" superheterodyne Series 105 receiver. The "Master All-Wave" console incorporates a single dynamic reproducer; model 50-A, 60 cycles and model 50-B, 25 cycles. The "DeLuxe All-Wave" console incorporates two reproducers; model 51-A, 60 cycles and model 51-B, 25 cycles. The "Radio-Phonograph" console incorporates phono., and dual reproducers.

The following values of the components are used in this receiver. Resistor R1, manual volume-control, 60,000 ohms; R2, tone control, 0.1-meg.; R3, R19, R20, 10,000 ohms; R4, 6,000 ohms; R5, 0.75-meg.; R6, 150 ohms; R7, R11, R14, R17, R25, 40,000 ohms; R8, R24, 4,000 ohms; R9, R22, 2,000 ohms; R10, 2 megs.; R12, 20,000 ohms; R13, 0.1-meg.; R15, 220 ohms; R16, 20 ohms; R18, 100 ohms; R21, R23, 45,000 ohms; R26, 1. meg.; R27, 540 ohms; R28, 1,760 ohms; R29, 4,600 ohms; R30, 2,700 ohms.

Condensers C1 to C5, tuning condensers; C1A, C2A, S.W. trimmers; C3A, C4A, C5A, R.F. trimmers; C6, trimmer; C7, C38, trimmers (one unit); C8, C16, C21, 500 mmf.; C8A, trimmer, C9, C15, 100 mmf.; C9A, trimmer; C10 to C13, I.F. trimmers; C14, trimmer; C17, C19, C27, C28, C37, .001-mf.; C18, .002-mf.; C20, C29, C40, .02-mf.; C22, C24, C30, C33, C42, 0.1-mf.; C23, C34, C41, .25-mf.; C25, 250 mmf.; C26, 1 mf.; C31, 0.5-mf.; C32, .003-mf.; C35, 8 mf. (25 cycles, 10 mf.); C36, 8 mf. (electrolytic); C39, 8 mf. (electrolytic).

In the phonograph models the circuit is open at X2, the dotted connections are made and the following values are used: RA, 0.1-meg.; RB, 2,000 ohms; CA, 0.1-mf.; CB, .25-mf. To use dual reproducers the circuit is broken at X3 and the extra reproducer socket is wired in as shown dotted.

Tube voltage readings must be taken with the set tuned to one of the short-wave ranges, and the local-distance switch Sw. 2 pulled out.

Filament potential, V1 to V5, V8, V9, 2.4 V.; V6, V7, 2.42 V.; V10, 2.44; V11, 4.9 V. Plate potential, V1, 21 V.; V2, 81 V.; V3, V4, V6, 188 V.; V5, 102 V.; V7, 70 V.; V8,

V9, 177; V10, zero. Screen-grid potential, V1, 2 V.; V3, V4, V6, 102 V.; V8, V9, 188 V.; V10, zero. Cathode potential, V1, 1.9 V.; V2, 5.2 V.; V3, 2.4 V.; V4, 9 V.; V5, zero; V6, -89 V.; V7, -92 V.; V8, V9, -97 V. (to grid, 16.5 V). Line, 115V.

During broadcast reception interference from short-wave stations is prevented by applying a very high negative bias on V2, preventing it from functioning.

The range switch consists of 8 independent switch sections, each being provided with 5 contacts. Ordinarily, only 7 sections are used, and only 4 of the 5-per-switch; the remainder are wired into circuit only in the radio-phonograph models.

1. The antenna is switched to the tuned input circuit of the short-wave detector; 2, the bias on the short-wave oscillator tube is reduced so that it can function; 3, the tuning condenser sections in the R.F., first-detector, and broadcast oscillator stages are cut out of the circuit and replaced by fixed trimmer condensers which are adjusted to tune these circuits to pass a 1,525 kc. signal. This frequency is used to prevent pick-up of broadcast-band stations during short-wave reception. The received short-wave signal passes through the short-wave detector where it is converted to 1,525 kc. by the action of the S.W. oscillator and it is then amplified at this frequency in the broadcast portion of the receiver.

The range switch operates in five positions as follows: 1, phonograph (this position cannot be reached in non-phonograph models); 2, broadcast range (position 1 in non-phonograph models); 3, 180 to 80 meters; 4, 80 to 33 meters; 5, 33 to 14 meters.

Reproducer part No. R-208-A has a field coil resistance of 460 ohms; No. RL-209-A (the L.F. unit in dual-reproducer sets), 230 ohms; No. RH-209-A, (the companion H.F. unit), 230 ohms.

In the model 105 receiver there are five circuits to be aligned, as follows: Broadcast R.F. amplifier 540 to 1,550 kc.; B.C., I.F. amplifier, 177.5 kc.; first S.W. circuit, 180 to 80 meters; second S.W. circuit, 80 to 33 meters; S.W. I.F. amplifier, 1,525 kc. The

third S.W. circuit will be aligned correctly if the first two are correctly aligned. A sensitive output meter must be used to obtain sufficient indication at the low service-oscillator output level required to prevent the A.V.C. circuit functioning. Turn R1 full-on, pull Sw. 2 out and turn R2 right.

Looking at the front of the chassis, the trimmer controls are located as follows: R.F. trimmers, from front to back, top of ganged condensers; I.F. trimmers, along rear of chassis, top of I.F. transformers; S.W. trimmers, left-center of chassis (rear-right of 5-gang tuning condenser). In the factory manual these units are given the following reference numbers: R.F. trimmers, front to back, 5 to 9; I.F. trimmers, left to right, 1 to 4; S.W. trimmers, 10 to 12.

To align the S.W., I.F. circuits, tune broadcast receiver to 1,525 kc. then switch to the 80-to-33 meter range and align 10, 11 and 12. In rare instances it may be necessary to align the remaining sections of the short-wave unit; however, this should be done only as a last resort, as follows:

Aligning 180 to 80 meter band. Tune the broadcast receiver to 800 kc.; switch to 180 to 80 meter band and tune to 1,600 kc.; adjust No. 14 for maximum output. Next, tune service oscillator to 975 kc., turn range switch to 80 to 33 meters, tune to extreme right position (4th harmonic) and adjust No. 5 for maximum output. If it is necessary to appreciably vary No. 5, repeat the procedure in adjusting No. 14.

Aligning 80 to 33 meter band. Tune the service oscillator to 925 kc., shift range switch to 80 to 33 meters, turn pointer to extreme left (4th harmonic) and adjust trimmer No. 13 for maximum output.

Next, set the service oscillator at 1,500 kc., tune to about 50 meters (4th harmonic) and adjust Nos. 6 and 15; the latter control setting is not critical.

It is very important that the aligning frequencies given in these directions be exact, otherwise, calibration and sensitivity, particularly at the third short-wave band, will be considerably below par.

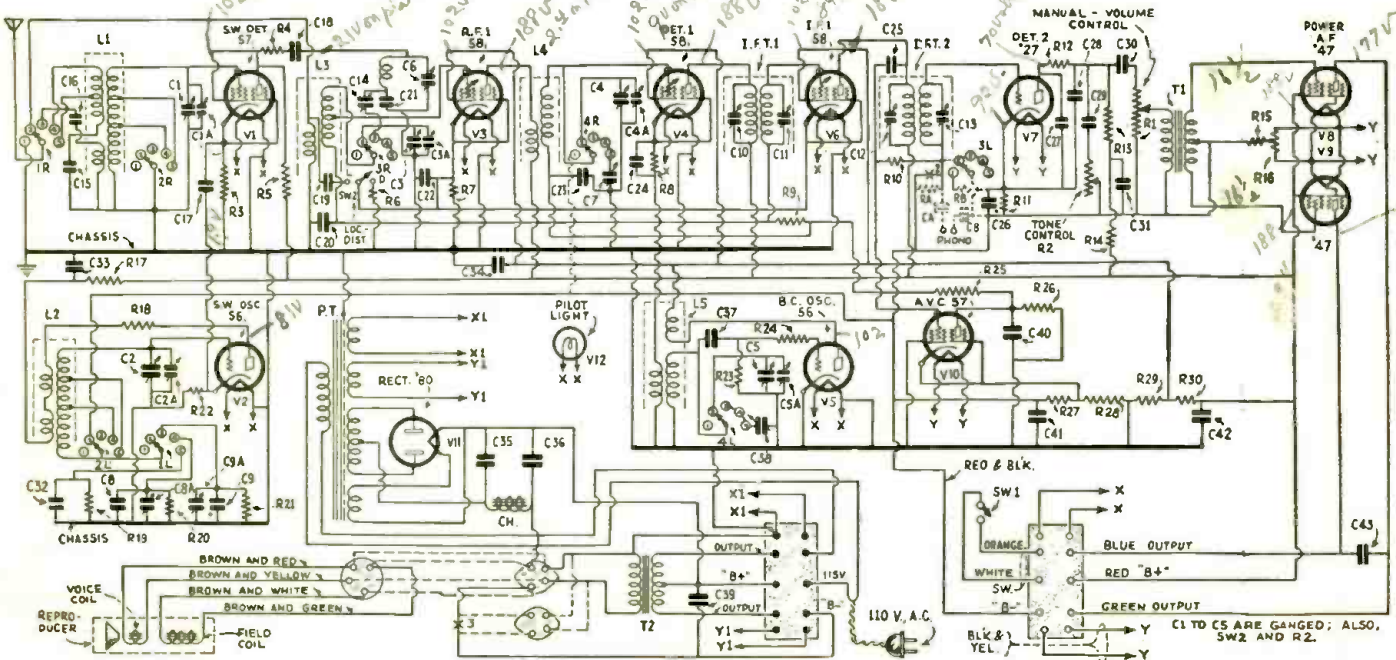

THE SERVICE MAN'S FORUM

Where His Findings May Benefit Other Radio Technicians

NORMAN VS. "PAPA" FREED

Editor, RADIO-CRAFT:

In the "Operating Notes" department of the October, 1932, issue of RADIO-CRAFT, Mr. Freed states that to cure low volume and distortion in some Philco model 91 receivers he changes the first A.F. tube with the detector and oscillator tube. I cannot see how this recommendation would help matters as the first A.F. tube is a type '37 and the detector and oscillator tube is a type '36.

H. E. NORMAN,
291 Lake View Park,
Rochester, N. Y.

(Mr. Freed has been absent from the columns of RADIO-CRAFT due to the fact that he has been ill and is now convalescing; we expect to have him with us again in a short time. Congratulate him, fellows—he became a daddy a short time ago! [Mother and "Bob" are doing nicely, thanks.] We print below his reply to Mr. Norman.—Editor.)

Editor, RADIO-CRAFT:

Referring to my notes in the October issue of RADIO-CRAFT, I find that a mistake occurred. The first A.F. tube was interchanged with the detector and amplifier tube, and not the detector-oscillator, which is a type '36.

This first A.F. tube, as the text relates, has often been found to be the cause of low volume and distortion.

BERTRAM M. FREED,
Coney Island Hospital,
Ocean Parkway,
Brooklyn, N. Y.

RE. THE STORY McMILLEN STICKS TO

Editor, RADIO-CRAFT:

I wish to take exception to a statement made by Mr. McMillen in your column of the November, 1932, issue, pg. 283, regarding the remodeling of Sparton models 69 and 79 receivers.

Mr. McMillen explains how to change these sets for UY '27 tubes instead of the Sparton 484 tubes and then states that the set works just as well with the type '27's as with the type '84 tubes. A little study will readily show this cannot be true.

The '27 has an amplification factor of 9 and, neglecting the small gain in the detector, five of these tubes will give an overall gain of 58,569 or 95 db. The '84 tube has an amplification factor of 12.5 and five of these will give an overall gain of 305,175 or 110 db. So it is readily seen that the type '27 tubes will not operate as satisfactorily as the type '84 when attempting

to obtain results on distant stations; however, the difference would probably not be noticeable on local stations. (The loss caused by the mismatching of impedances has, of course, been neglected in these figures; this item would lower the gain of the '27's.)

The writer has found that the Sparton battery-set model 39 is very easily converted to A.C. operation for using either the type '27 tubes or the type '84 and makes a fine A.C. set.

The tuning unit of the model 39 receiver is identical with that of the 69 and 79; the amplifier contains five-prong sockets, but the cathodes are not connected. All that is necessary is to install a power pack, rewire the filaments with twisted leads, and connect the cathodes to the volume control. If '27's are used it is better to use six of them as R.F. amplifiers and place the detector outside of the amplifier case. This will give a total gain of 527,931 or 115 db. which is somewhat better than five type '84 tubes. An A.F. amplifier must, of course, be added, and this may be whatever type one desires. The writer has used two type '47 tubes in push-pull and obtained excellent results.

R. E. WILLEY,
4629 York Avenue, South,
Minneapolis, Minn.

Editor, RADIO-CRAFT:
Concerning the interesting technical discussion of Mr. Willey, I wish to
(Continued on page 435)



Official lapel button of the O. R. S. M. A.

tained solely for the interests of Service Men. Membership cards are issued upon passing a written examination which is forwarded by mail. Write for yours today. The O.R.S.M.A., 98 Park Place, N. Y.

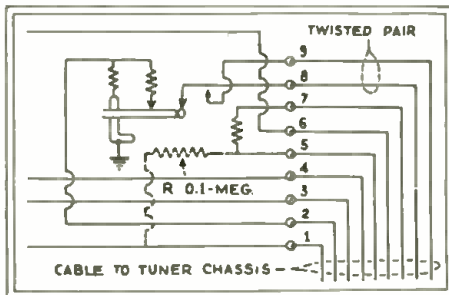

Fig. 1

Schematic circuit showing the location of the .1-meg. resistor.

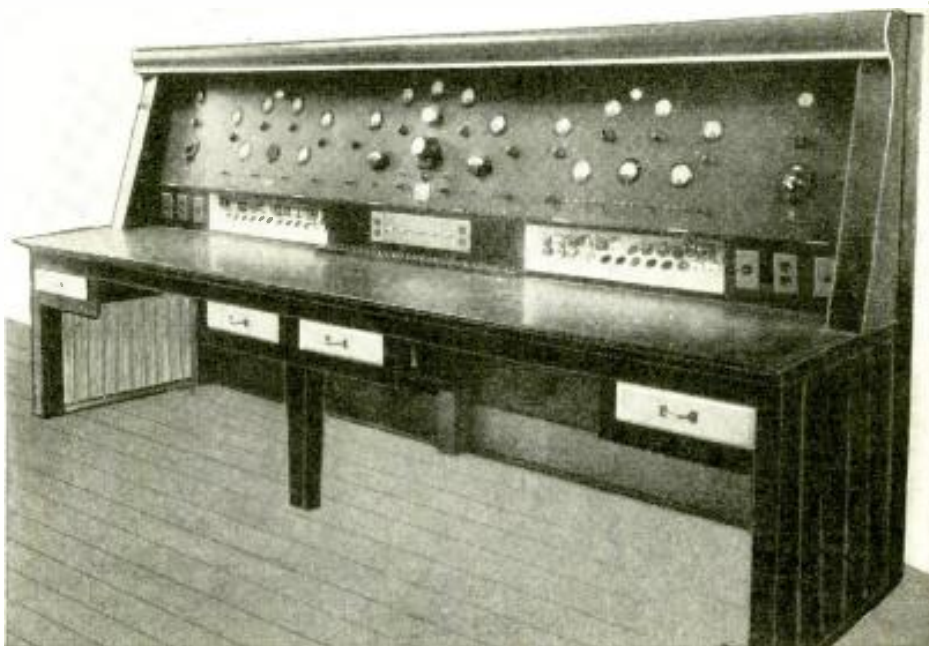

Fig. A

Don't turn green with envy; this beautiful shop cost \$950.00.

RADIO-CRAFT KINKS

Practical Hints From Experimenters' Private Laboratories

Prize Award

A SUPER-SELECTIVE CRYSTAL RECEIVER

Lawrence B. Johnson

IN Fig. A is illustrated a crystal receiver which incorporates a band-selector. The desirability of such an arrangement is evident to anyone who has experimented with crystal detectors. The schematic circuit is Fig. 1A; at B is shown a simple amplifier arrangement which may be used if desired (any convenient units may be used for T and V).

The number of turns in L controls the degree of band-selection.

UNIFORM MOUNTINGS FOR METERS

Pat Daly

OFTEN a testing panel or "ham" transmitter panel will be designed to use meters of a standard, relatively large size. Occasionally, the needed range will be in a smaller size. To make all panel holes the same size and also present a symmetrical layout, the

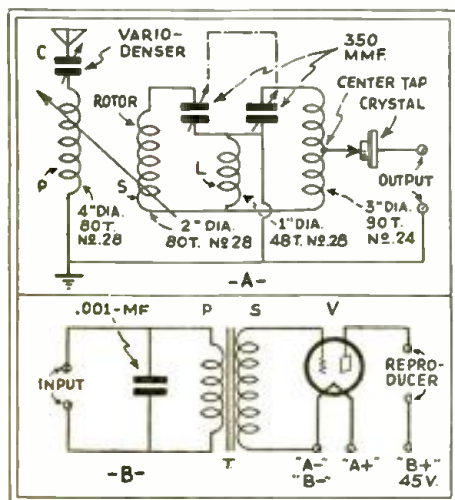

Fig. 1

The super-selective crystal receiver. An amplifier arrangement is shown at B.

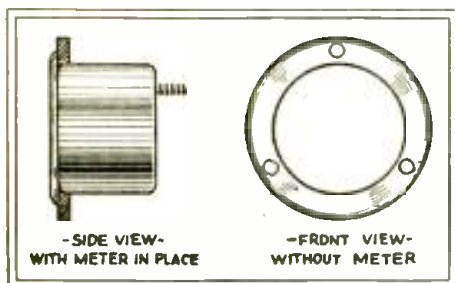

Fig. 2

With this idea any meter may be enlarged.

\$5 for a Practical Radio Kink

As an incentive toward obtaining radio hints and experimental short-cuts, "Radio-Craft" will pay \$5.00 for the best one submitted each month. Checks will be mailed upon publication of the article.

The judges are the editors of "Radio-Craft" and their decisions are final. No unused manuscripts are returned.

Follow these simple rules: Write, or preferably type, on one side of the sheet, giving a clear description of the best radio "kink" you know of. Simple sketches in free-hand are satisfactory, as long as they explain the idea. You can send in as many kinks as you wish. Everyone is eligible for the prize except employees of "Radio-Craft" and their families.

This contest closes on the 15th of every month, by which time all the Kinks must be received for the next month.

Send all contributions to Editor, Kinks Department, c-o "Radio-Craft," 98 Park Place, New York City.

following method may be used: A washer of bakelite is cut with the circle cutter or scroll saw, the outside diameter being equal to the flange of the meter and the inner hole to fit the meter, as illustrated in Fig. 2. By mounting a small meter in this way the panel arrangement looks much better and the larger meter may be put in at any time.

A "5 AND 10" MIKE STAND

Joe Wilfinger

FOR the experimenter who cannot afford a "commercial" microphone stand, the writer offers the construction illustrated in Fig. 3. Most of the parts

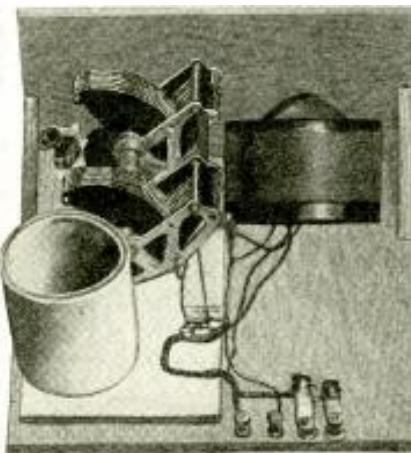

Fig. A

Photograph of the selective crystal set.

can be obtained in a "five and dime" store; the total cost is only about fifty cents.

I am using this stand with a P.A. system for orchestra purposes and find it very easy to transport. The microphone together with its ring, may be removed and kept in a padded box (to prevent damage) when not in use.

A DYNATRON ONE-TUBE ELECTRIC SET

W. E. Chorpenny

IN Fig. 4 is illustrated a dynatron detector circuit which has lots of pep, and on many stations is too loud for comfort when using headphones; the tone quality is excellent, and selectivity is (Continued on page 431)

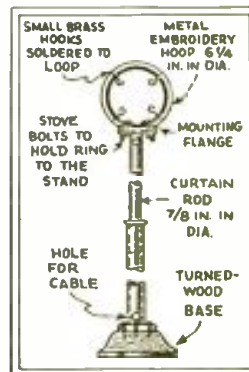

Fig. 3
Ah, at last! The 5 and 10 "mike" stand.

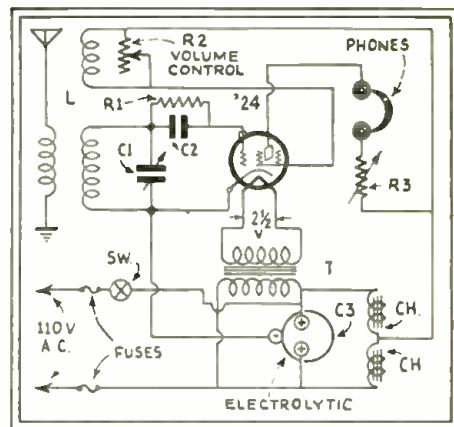

Fig. 4

Schematic circuit of the dynatron detector circuit.

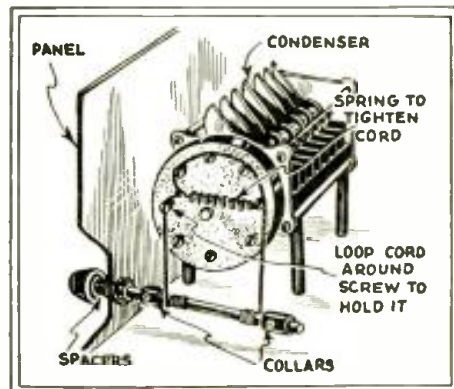

Fig. 5

That troublesome drum-dial problem is simple now.

IMPROVING S. W. RECEIVER DESIGN

R. Wm. TANNER

IT SEEMS to be the vogue, just at present, to increase the number of tubes, particularly in the case of short-wave superheterodynes. This is not as it should be in these days of depression. There are short-wave "supers" now on the market employing up to 16 tubes. To be sure, such a set has extreme sensitivity and volume but due to background noises, it is never possible to use all of the power available.

If each tube is employed to its greatest efficiency with all component parts of best grade, the writer believes that a six- or seven-tube set (including rectifier) will give as satisfactory results as one with many more tubes.

In one manufactured short-wave superhet, that the writer had occasion to look over, the I. F. amplifier employed three I. F. stages. Tuning was very smooth, but the amplifier was altogether too stable. As the shielding was nothing exceptional and the I. F. filtering was not even fair, it was decided to find out the reason for the lack of feedback. A close examination proved that the I. F. transformer primaries consisted of only one-fifth the number of secondary turns, resulting in very low I. F. gain per stage (the reason, no doubt, for the three I. F. stages; two would have been quite sufficient if the coupling transformers had been correctly constructed.) Furthermore, the transformers were mounted only $\frac{1}{4}$ in. from the shield can—another good reason for the lack of gain.

There is another condition existing in short-wave supers which can cause as much trouble as in a broadcast set and that is cross-talk. The use of a variable-mu tube as first-detector preceded by a two-section band-selector will entirely eliminate this "horror," the band-selector also functioning to prevent image-frequency interference, a condition much worse on the short-waves than on the broadcast band. (With many supers, lack of sufficient selectivity before the first-detector results in the reception of many undesired code stations.)

There is another important advantage to the use of a variable-mu tube as a first-detector. Due to the low value of control-grid bias required, this tube may be used as a second-harmonic oscillator as well as a detector. With proper coils, this arrangement is every bit as good as a separate oscillator; at the same time one tube is saved. Figure 1A shows a type 58 pentode tube employed as a combination first-detector and oscillator. It will be noted that the plate circuit contains the tuned winding of the oscillator, the feedback coil being in the cathode circuit, (or it may be placed in the control-grid lead if desired). Both the oscillator and the band-selector coils *must* be completely shielded.

If shielding and R. F. filtering are exceptionally good throughout the receiver, we can still improve operation by inserting a tuned circuit L-C in the detector control-grid lead, as shown at X in Fig. 1A. This coil and condenser combination is peaked at the same frequency as the I. F.

transformers and must also be placed within a shield can of correct dimensions. With this extra device, the gain in the first-detector stage is very nearly equal to that of an I. F. stage. The L-C circuit should preferably be of the high-C type, that is, a high ratio of capacity to inductance, as this helps to prevent I. F. feedback in the detector stage.

As a vacuum tube is a voltage-operated device, anything that tends to reduce the R. F. voltages will certainly tend to decrease the possible gain. Consequently, short-wave tuning coils should be wound for minimum R. F. resistance and for the three lower wave bands, 20, 40 and 80 meters, should be space-wound. This is a simple problem but even though the coils have low losses, placing them within shields that are too small will cause the high-frequency resistance to rise, not only decreasing the effective voltage applied to the grid but causing broad tuning as well. The use of wire larger than No. 24 is of no benefit whatsoever since the greater wire diameter results in increased distributed capacity.

The construction of the I. F. transformers should be given considerable attention, although resistance loss here is not so important as in the signal-frequency circuits. In order to apply the highest possible voltages to the tube grids, the tuned circuits should have a low —C ratio; in fact, to reduce the self-capacity of the coils they should be wound in the form of honeycombs and with the turns spaced instead of close-wound as in the modern broadcast-type, lattice-wound, I. F. transformers. For this reason the writer prefers I. F. transformers of the inductance-tuned type, made by mounting four coils to slide on a common rod, as shown in Fig. 1B. Two of

these coils, A and B, in series constitute a variometer primary L1, and the remaining two, C and D, the secondary L2. Varying the coupling of B and C, ordinarily about $1\frac{1}{2}$ ins., determines the selectivity. These units have been employed in many experimental circuits with improved results over the conventional capacity-tuned types. These inductance-tuned, I. F. transformers permit a higher load impedance with a better match for high-impedance tubes such as the screen-grid and pentode, particularly the latter.

All of the I.F. coils tuned by the 140 mmf. condensers, including that in the first-detector grid circuit, are 1.2 mhy. (they are made by F. W. Sickles Co.). The I.F. coils after the first I.F. tube consist of two coils for both primary and secondary, each having an inductance of 1.2 mhy.; two connected in series, in each circuit, constitute the variometer arrangement.

The R.F. chokes are 20 to 90 mhy. for the screen-grid, "B" positive and cathode circuits; for the crystal detector plate, either a 250 mhy. or two 50 to 90 mhy. units. The choke in the first-detector plate lead to the top of the first I.F. transformer must be quite small to prevent choking the I.F. currents; (I used in many sets a Sickles 1.2 mhy.

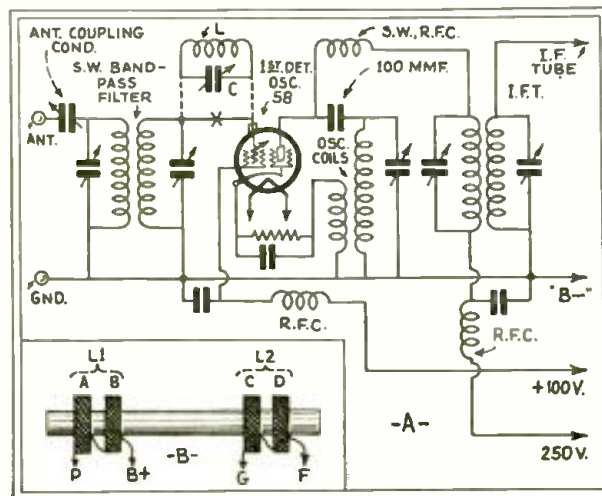

Fig. 1
This circuit illustrates the manner in which a tuned circuit is inserted in the receiver for increasing the sensitivity of the detector. At B, an I.F. coil arrangement is given.

Here is a real, honest-to-goodness article by a short-wave authority which tells you exactly what the requirements are for successful operation on the short wave-lengths. This article is devoid of all theory, and the conclusions are backed up by an excellent receiver whose data are given here. You should read this article and convince yourself.

lattice-wound coil.)

Giving the turns and sizes for such chokes and I.F. coils would only absorb valuable space, since no ham can make two consecutive coils alike, without expensive machinery; lattice-wound coils are almost impossible to make by hand.

The plug-in short-wave coils are wound on bakelite forms which just fit over a tube base and bolt to it; both the antenna and the detector grid coil are wound alike, as follows: for 20 meters, 5 T.; 40, 10 T.; 80, 21 T.; 160, 45 T. Number 26 enam. wire is used, close wound. The coils are separated on the forms approximately 1½ ins. to give a band-selection effect.

The oscillator coils are on the same size forms, to the following specifications: 20 meters, 5 T., 5 T.; 40, 10 T., 6 T.; 80, 19 T., 8 T.; 160, 34 T., 10 T. The first figure indicates the number of primary turns and the second, the cathode. The same wire and spacing are used as mentioned in the paragraph above.

In order to realize the greatest possible gain, all stages should be completely shielded, including the respective tube (which must be separately shielded), coils, bypass condensers and resistors; the R.F. chokes may be located outside the shields. All screen-grid and plate leads should be filtered, by means of a good R.F. choke without dead-spots, and the correct size of bypass condenser (these directions include the first-detector). It should be mentioned that, especially with the new R.F. pentodes, shielding which employs only a separate shield-can for the coils and a separate tube shield will not do if all regenerative feedback is to be eliminated; *stage shielding is an absolute necessity*. However, if all shielding and filtering precautions are strictly observed, feedback will be reduced to a very low value and high gain per stage will be obtained.

From the viewpoint of tone quality or, in television, picture quality, the greatest source of distortion is the second-detector; even though the new type 57 pentode is an especially fine detector, giving a high audio output with only a small R.F. input, there is some distortion present. The writer has for the past two years been experimenting

with crystal detectors in modern, high-gain receivers. In every case tone and picture quality are far better than with a tube second-detector. All types of crystals have been used including galena, silicon, zincite-tellurium, carborundum and a German unit termed a Rotorit. The carborundum detector has always proved the most stable and sensitive and will handle a higher R.F. input than others; the Rotorit comes next, with the zincite-tellurium a close second. The carborundum unit requires a small, D.C. bias (conveniently obtained from the power pack) for greatest sensitivity and good tone quality. For television reception, a crystal detector offers a very simple means of changing from a positive to negative picture, merely by reversing the detector connections. With a carborundum crystal, reversing the connections also requires a change in polarity of the bias voltage; a potentiometer will effect the change.

The audio output of a crystal is not as high as with a tube due to the fact that a crystal has no amplification properties, which means that two A.F. stages should be employed if the power tube is to be operated at full capacity. A type 57 voltage amplifier and a type '47 power stage are an ideal combination to be used after a crystal second-detector.

A peculiar condition exists in the output of a crystal
(Continued on page 435)

WHAT THIS ARTICLE TELLS YOU

- It tells you what precautions to take in building S.W. receivers.
- It tells you the advantages of the new tubes.
- It tells you of the use of a crystal detector in modern S.W. sets.
- It tells you everything you want to know

ABOUT SHORT-WAVE RECEIVERS

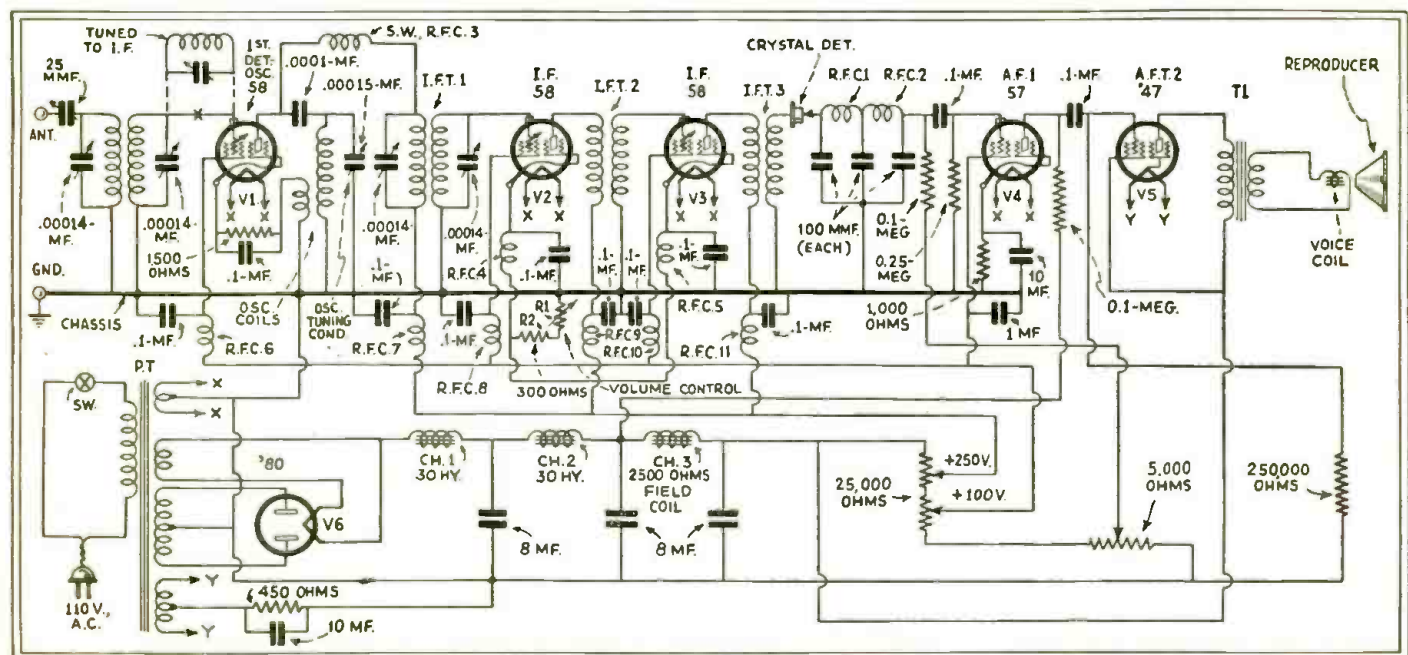

Fig. 2 Complete schematic circuit of the receiver embodying all the principles set forth in the text.

THE RADIO CRAFTSMAN'S PAGE

The Bulletin Board for
Our Experimental Readers

"MORE TUBES? (!)," PRO—

Editor, RADIO-CRAFT:

There was one article in the October issue which appealed to me particularly, that was in connection with C. M. Delano's letter.

I think it would be a great idea to produce a series of tubes the size of the "peanut" tube, with a low-drain filament. Also, the screen-grid and pentodes would be a splendid addition to this line. I think that this line of tubes should be designed with a 1.1 V. filament with a drain of 60 ma. or less and, if possible, a plate voltage of not more than 90 V.

I believe you are always anxious to receive suggestions as to what the readers of your magazine would like to see published and I am offering one which would interest me and, I am sure, would be of interest to many other beginners in the radio business. I would like to see more articles published giving information on operating procedure and routine work in various branches of the radio art, e. g., articles describing operating procedure and routine work in transmitting stations both on land and ships, and also in the projection booth, and numerous other branches of the art.

I remain, a booster for the Gernsback Publications.

DALTON NEWBERRY,
R. R. No. 1
Port Hancy, B. C., Can.

—AND CON

Editor, RADIO-CRAFT:

Referring to Mr. Delano's article on page 238 of the October, 1932, issue of RADIO-CRAFT, I, for one reader, am not in accord with him in this instance, as I think we already have too many tubes and, furthermore, do not believe in keeping these relics running forever. I suggest, rather, that every tube older than the 2-volt series and the new "50" line be discontinued as any set these cannot be adapted to is practically worthless.

I have seen '30's substituted for '26's with improved results in performance and economy, and the 56 substituted for the '27 with similar satisfactory results.

To go a bit further, I'm in sympathy with Philco's idea of using the 6.3-volt "automotive" series of tubes in A.C. sets, thereby having but two series of tubes.

Also, I think development of a 6-volt

IMPORTANT NOTICE

In the interest of those readers who do not like to mutilate this magazine, we have asked some of our advertisers not to place coupons in their advertisements.

Instead of the usual coupons, you will find a number of convenient post cards inserted between the last page and the back cover of this magazine.

This new service will save you time and work. No need to cut coupons, nor is it necessary to hunt for and address envelopes. Moreover the space for your name on a coupon is usually so small that the advertiser is often not able to make out your writing and then you wonder why you do not get the literature sent for.

Then, last but not least—the postage for a postal card is only 2c whereas a letter now costs 3c.

Read the advertisements and then turn to the page containing the special postal cards. Detach, fill out and mail the card of the advertiser whose literature or offers you want to have sent to you.

Mail your card today! Show the advertisers that you appreciate their cooperation and thoughtfulness.

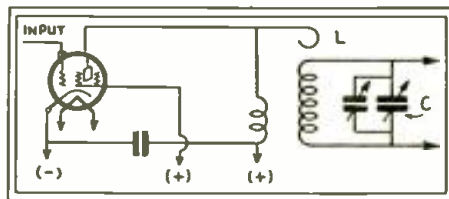

Fig. 1
Circuit details of an R.F. transformer

"air cell" battery for use with the 2-volt tubes and an automotive type of "B" eliminator, would be a boon to the battery set, thereby eliminating all but two battery connections.

JOHN R. REGIS,
115 N. Pittsburgh St.,
Spokane, Wash.

("You pays your money an' you takes your choice"; there you have two sides of the story, fellows, which do you want to take? It is interesting to observe that both gentlemen hail from the far Northwest. Local conditions undoubtedly influence Mr. Newberry's plea for tubes having lower current requirements. Mr. Regis exhibits a broader understanding of the chaotic conditions existing today in the radio tube field, and makes some very logical proposals, [in line with the step which has been taken by Philco, as pointed out last August in Radio Service Data Sheet No. 71, "Philco Model 15 Series,"

concerning the exclusive use of 6.3-volt tubes in A.C. receivers], toward their mitigation.—Editor.)

IMPROVING "THE A. C. PENTODE PORTABLE"

Editor, RADIO-CRAFT:

In the September, 1931, issue of RADIO-CRAFT, page 156, you published plans for a portable set consisting of only a '24 detector and '47 amplifier. You requested all builders of the set to report on it. "Better late than never," so here goes.

At first, I could not get the '24 detector to work, so I changed over to a '27. The volume was good considering the number of tubes. Finally, I found that the plate and screen-grid voltage on the '24 were the same and hence it did not function. By fixing this, the '24 worked with astounding volume.

The set has truly wonderful tone and volume. In the heart of Philadelphia, I have no difficulty in picking up, with good volume, station programs 500 miles distant. However, I find that a 250 mmf. condenser in the antenna circuit, as unit C, gives better volume.

J. J. FOSTER,
5938 Sansom St.,
Philadelphia, Pa.

HARK TO "AUSSIE," 10,000 MILES AWAY

Editor, RADIO-CRAFT:

It has been my pleasure to have been a reader of the different publications edited by Mr. Gernsback and I must say that I have gleaned some very valuable information from the columns of his magazines, but, there is one thing that I'd like to see in them—more detail; probably other readers of your paper, in the different countries where RADIO CRAFT circulates, would be similarly gratified.

In your articles for set construction, the List of Parts always includes a manufactured kit of coils which is never procurable in Australia. Also, the brand of power pack mentioned is unprocurable here; although, if the voltages actually read, on the set, with a resistance voltmeter, were given from, say, the plate of the tube to the cathode or chassis, as the case may be, it would be a check for us to know whether everything is O.K.

Further, might I suggest that the
(Continued on page 434)

16 TUBE ROUND THE WORLD RADIO **39.95** now only \$

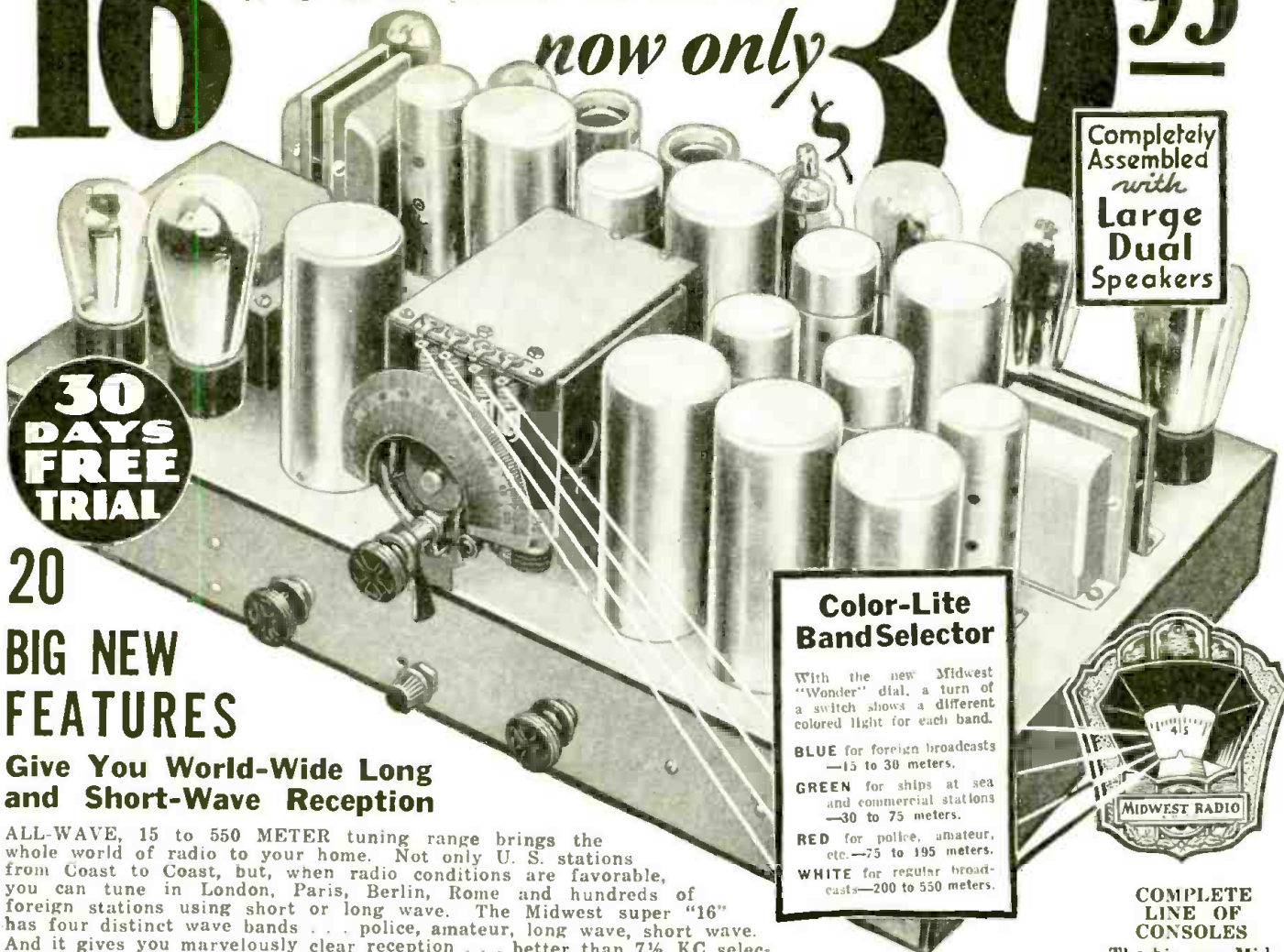

30 DAYS FREE TRIAL

20 BIG NEW FEATURES

Give You World-Wide Long and Short-Wave Reception

ALL-WAVE, 15 to 550 METER tuning range brings the whole world of radio to your home. Not only U. S. stations from Coast to Coast, but, when radio conditions are favorable, you can tune in London, Paris, Berlin, Rome and hundreds of foreign stations using short or long wave. The Midwest super "16" has four distinct wave bands . . . police, amateur, long wave, short wave. And it gives you marvelously clear reception . . . better than 7½ KC selectivity. With the wonderful new matched dual speakers, tone control and STAT-OMIT tuning silencer, you will enjoy sensationally clear and smooth radio reception such as you have never known. And above all, you will enjoy absolutely faithful tone reproduction. Thousands of Midwests are giving wonderful satisfaction in every State of the Union and forty-nine foreign countries as well. No radio at any price can give you better reception than this famous Midwest which you buy direct from the factory at a sensationally low price.

TERMS AS LOW AS \$5 DOWN

4 Sensational New Midwest Features

Midwest 1933 ALL-WAVE radios have all the worthwhile improvements and many exclusive Midwest features. Outstanding among the important advantages of these big powerful sets are these:

STAT-OMIT Tuning Silencer
An inter-station silencer or noise suppressor that automatically omits all in-between-station noises, swishing, cracking and frying. This new method gives perfect tuning without Neon lights, visual meters or buttons formerly required.

Class "B" Amplification
Gives absolutely faithful reproduction of all tones and overtones. Enormous reserve power capable of reproducing any instrumental combination of the most powerful orchestra. Handles the full volume of the largest pipes of the grand organ.

Dual Speakers
Two full electrodynamic speakers for complete audible tone range, especially designed for the tremendous power output of the new tubes.

One Chassis—One Dial
Only one chassis for everything, 15 to 550 meters. Regular broadcasts, police, amateur, ships at sea, commercial stations, foreign short-wave broadcasts. No converter or other auxiliary units used. All bands controlled by one dial.

Deal Direct With Factory Save UP TO 50%

Midwest sweeps aside the costly old-fashioned way of selling through jobbers and dealers. You buy direct from the factory. You have 30 days trial in your own home and a positive guarantee of satisfaction or money back. If you wish, you may pay for your Midwest in small monthly sums that you'll scarcely miss. Remember . . . only \$10.00 down puts even the biggest and finest Midwest in your home now. Some models as low as \$5.00 down. Investigate! Mail the coupon. Get the Midwest catalog. Learn the facts about Midwest 12- and 16-tube ALL-WAVE sets. Get a bigger, better, more powerful, better toned radio—at a positive saving of 30% to 50%. Mail the coupon or write us a postal right NOW!

MIDWEST RADIO CORP.
Dept. 168 (Est. 1920) Cincinnati, O.

Completely Assembled with Large Dual Speakers

Color-Lite Band Selector
With the new Midwest "Wonder" dial, a turn of a switch shows a different colored light for each band.
BLUE for foreign broadcasts—15 to 30 meters.
GREEN for ships at sea and commercial stations—30 to 75 meters.
RED for police, amateur, etc.—75 to 195 meters.
WHITE for regular broadcasts—200 to 550 meters.



COMPLETE LINE OF CONSOLES

The big new Midwest catalog shows gorgeous line of artistic consoles in the new six-leg designs. Mail the coupon now. Get all the facts.

Read These Letters!

"Am having good results with my 16-tube Midwest. On the short wave I have had most all of the large stations. I get several of the Airport Stations and amateur stations a plenty. Had G5SW, LEX, Buenos Aires, VK2ME, VK3ME, Sydney, VE9GW, Bowmanville, Canada, Pointoise, France and Nauen, Germany."

R. P. REYNOLDS,
P. O. Box 1125, Orlando, Fla.

"The 16-tube radio arrived yesterday, got it going today and to express myself in a few words . . . What a radio! What a tone! What a surprise! Really, it is more radio than I ever dreamed of seeing incorporated in one chassis. It's wonderful!"

L. F. KIMMELL,
7324 Wakefield Ave.,
Cleveland, O.

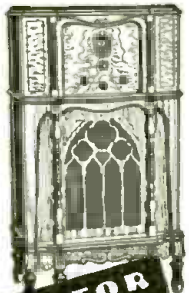

RUSH THIS COUPON FOR AMAZING FREE TRIAL OFFER AND BIG BEAUTIFUL CATALOG

Midwest Radio Corp.
Dept. 168
Cincinnati, Ohio.

Without obligation on my part send me your new 1933 catalog, and complete details of your liberal 30-day free trial offer. This is NOT an order.

USER AGENTS EASY EXTRA MONEY
Check here for details.

Name
Address
Town State

RADIO-CRAFT'S INFORMATION BUREAU

SPECIAL NOTICE TO CORRESPONDENTS: Ask as many questions as you like, but please observe these rules:

Furnish sufficient information, and draw a careful diagram when needed, to explain your meaning; use only one side of the paper. List each question.

Those questions which are found to represent the greatest general interest will be published here, to the extent that space permits. At least five weeks must elapse between the receipt of a question

and the appearance of its answer here.

Replies, magazines, etc., cannot be sent C. O. D. Inquiries can be answered by mail only when accompanied by 25 cents (stamps) for each separate question.

Other inquiries should be marked "For Publication," to avoid misunderstanding.

MIDWEST 16-TUBE ALL-WAVE SUPERHETERODYNE—CORRECTIONS

(182) Mr. Victor Petsch, Newark, N. J.

(Q. 1.) What is the schematic circuit of the 16-tube all-wave superheterodyne which is being put out by the Midwest Radio Corp.? What technical information is there available concerning the components used in this set?

(A. 1.) In Fig. Q182A is illustrated the diagram of connections employed in latest-model, all-wave superheterodyne manufactured by the Midwest Radio Corp.; this is the Model 16 receiver. The values of the components are as follows:

Condensers C1, C2, C3, tuning condensers; C1A, C2A, C3A, R. F. trimmers; C4, .001-mf. padding condenser (mica); C4A, padding trimmer; C5, trimmer; C-6 to C11, I.F. trimmers; C12, C15, C16, C18, C19, C22, C23, C24, C26, C29, C30, C34, C36, C37, C38, C40 to C44, C46, C47, C53, .05-mf.; C14, C31, C35, 20 mmf. (mica); C17, 250 mmf. (mica); C20, .001-mf.; C21, 1. mf. (electrolytic); C25, 0.1-mf.; C27, 24 mf.; C28, .001-mf., padding condenser (mica); C32, C33, .002-mf. (mica); C39, 50 mmf. (mica); C45, C49, C52, 8 mf. (electrolytic); C48, C50, 4 mf. (special); C51, 4 mf. (electrolytic).

Resistor R1, manual volume control, 0.5-meg.; R2, "silent tuning" control, 1,000 ohms; R3, tone control, 50,000 ohms; R4, R9, R13, R21, R24, R36, R45, 31,000 ohms; R5, 10,000 ohms;

R6, 100 ohms; R7, R11, R14, R16, R17, R26, R27, R28, R29, R31, R35, R38 to R43, 0.2-meg.; R8, R12, R20, R23, R25, R30, R37, 50,000 ohms; R10, R15, R19, 2,000 ohms; R18, 700 ohms; R22, 15,000 ohms; R32, 410 ohms; R33, 3 meg.; R34, 5,000 ohms.

The power rating of this set is 150 W. The sensitivity is better than 1. microvolt absolute and the rated power output is approximately 20 W. One of the dual reproducers is a 10 in. dynamic unit and the other is an 8 in. model. A master wave-change switch controls the R. F. detector and oscillator circuits; at the same time, a corresponding colored pilot light identifies the band.

(Q. 2.) Is it possible to make a really sensitive crystal set?

(A. 2.) The sensitivity of a crystal set is mainly dependent upon the sensitivity of the particular piece of crystal used as the rectifying element. However, the high power in use today by a great number of stations renders it necessary to use some form of selector circuit which will enable the high-power "locals" to be tuned out in order to hear the more distant stations.

(Continued on page 442)

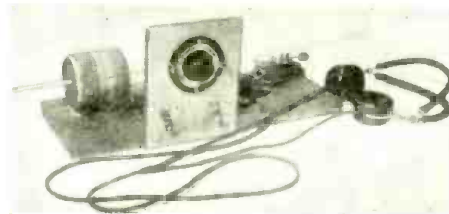

Fig. Q182B
Photograph of the sensitive crystal receiver.

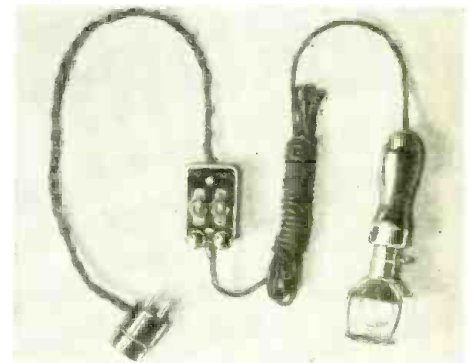

Fig. Q182C
Photograph of the device used to obtain power from receiver power units

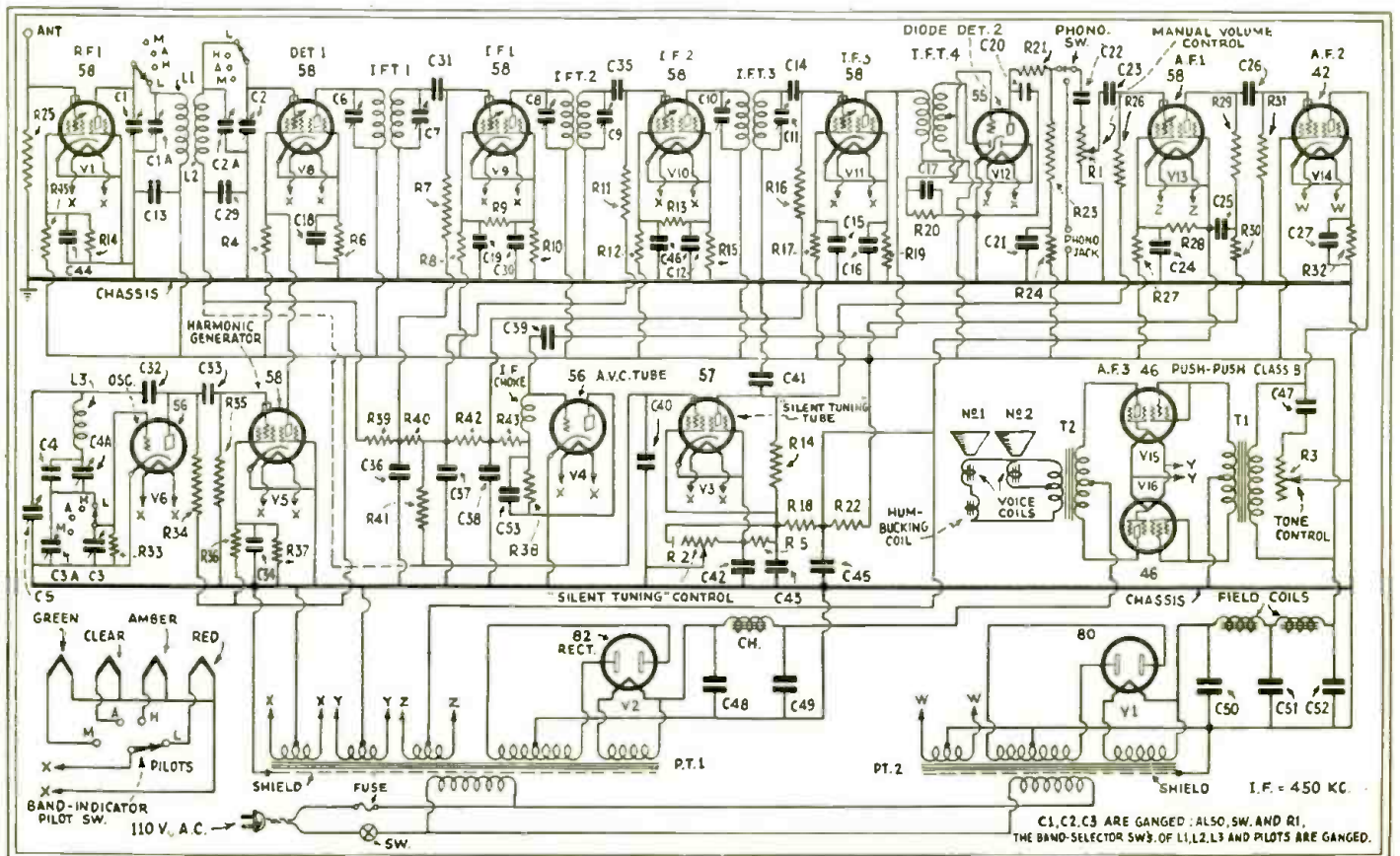

Fig. Q182A

Complete schematic circuit of the Midwest 16 tube receiver, a question concerning which was asked by Mr. Petsch.

METERLESS TUBE TESTER

(Continued from page 395)

oscillates, a key may be inserted to break the "H" supply for code-practice work. The posts are shorted for ordinary, tube-testing work.

Construction of the Tester

The construction of the tester is so simple that with the help of the circuit diagram and the photographs the experimenter will have no difficulty in building this device. The arrangement shown in the photograph of Fig. C for mounting the two dry cells under the sub-panel is economical, although some may prefer to place the batteries in a box and mount everything else on the horizontal panel which could then serve as a cover for the box. However, the arrangement shown is preferred by the author.

It should be noted that the transformer, A.F.T., has a variable ratio, and that the primary terminals P and B+ are not reversed, although they may have to be, if a make of transformer is used other than that specified. With the ratio chosen as indicated in the List of Parts, the tube will oscillate readily.

A word about mounting the dials. Both a Remler potentiometer and rheostat are used. If the builder uses some other make, then the chart given here will not be of much service, and a complete calibration table must be made. The choice, however, is left to the discretion of the reader.

Be sure to indicate the position of the switches by some mark on the panel, otherwise you may be forced to guess—and guessing is always a "shaky proposition."

As a check, in order to be sure that the tubes are getting the proper filament voltage, connect a voltmeter across the filament terminals of a '27 tube placed in the 5-prong socket. The reading should be 1.5 volts with the rheostat, R2, placed at position 7.

Miscellaneous Considerations

Do not let the low cost of this simple tester lead you to believe that it is less accurate than the more expensive testers using elaborate meters. The ordinary tester rates the value of a tube by measuring its filament emission. This single characteristic, while it undoubtedly has a great deal of merit, does not necessarily mean that all other characteristics (such as mutual conductance) are normal. The fact that a tube may work fairly well with its filament emission slightly below par, or conversely, that a tube with normal emission may function poorly in a receiver, must be admitted as a possibility by all qualified observers. The former case was demonstrated forcibly when a test was run on a series of 18 tubes on a commercial tester (using meters, of course). The results of the test were then compared with the results obtained on the meterless tester described here. In 17 of the tubes, both tests agreed; but in the 18th case, they disagreed. The commercial tester rejected the tube, while the meterless tester pronounced it workable. On trying this tube (it was a '27) in an actual receiver under working conditions, it performed satisfactorily, thus illustrating the point mentioned above.

The tester described here tests tubes under conditions which are parallel to actual operating conditions. The test is not under exact conditions because the voltages applied to the tube by the tester are not normal. However, since the calibration of the tester is made by comparing the readings of good and bad tubes, exact operating potentials are not necessary—nor desirable—for the simple reason that it would be difficult to differentiate between a good and a poor tube with high voltages applied; portability and cost would also suffer under these conditions.

Operating the Tester

To operate the tester, let us assume that all switches are thrown to their normal positions as shown in the schematic circuit of Fig. 2. The rheostat is set at the position indicated on the chart for the tube under

Whatever resistor you need—it's here!

I R C

RESISTORS



POWER WIRE WOUND



MOTOR RADIO SUPPRESSORS



PRECISION WIRE WOUND



Metallized

A complete line—and the only complete line on the market

Why shop around to find resistance units for your different purposes? They're all in the I. R. C. line—and all in the new I. R. C. Catalog.

We manufacture every type you want—and wherever you are, you can readily buy them. I. R. C. distributors are located in all parts of the country—in virtually every leading city—and in foreign lands. And every resistor bears the quality label known the world over—"I. R. C." LOOK FOR THIS TRADEMARK.

Only a glimpse of I. R. C. products is possible in this advertisement. But the full data is yours for the asking in our new catalog, showing resistors, resistor kits, service helps, instructions for making your own apparatus, and technical information on electrical characteristics of all I. R. C. units.

INTERNATIONAL RESISTANCE CO.

2006 Chestnut Street, Philadelphia, Pa.
74 Wellington St., West, Toronto, Ontario, Canada



Write for FREE Catalog. Ask for Form F-6.

GET THE

new

Centralab VOLUME CONTROL GUIDE FOR REPAIRMEN

free 50¢

We want every service man to have a free copy of this valuable book.

Illustrated, it contains 64 pages of interesting, necessary information. Priced regularly at 50c . . . it is yours for the asking. Enclose two 3c stamps to cover postage and wrapping and get this 50c GUIDE FREE.

Write on your own or your firm's stationery

- CENTRALAB Volume Controls for Replacements
- CENTRALAB Fixed Resistors
- CENTRALAB Radio Suppressors

Centralab
CENTRAL RADIO LABORATORIES
930 E. Keefe Ave. Milwaukee, Wis.



The House of all Types of Microphones and Public Address Systems

To the radio industry MAYO offers a complete line of Microphones and Amplifiers for broadcasting, recording and public address work. Every product is exclusively manufactured by MAYO, and tested to meet standard requirements.

Our engineers, after exhaustive research, have produced MAYO microphones and public address systems, at a cost far below that at which other similar products may be obtained and they have incorporated every modern improvement in their design.



The Talk of the Industry

MAYO Model F: 3 1/4" diam. by 2 1/4" thick; two button mike, 24 karat gold contact, 100 or 200 ohms per button; heat-treated duraluminum diaphragm; frequency, 60 to over 1000 cycles; weight (shipping) 1 3/4 lb.; furnished in two models 1-damped and 2-sensitive; new process carbon granules; unconditionally guaranteed for three months. Price

\$15.00

PUBLIC ADDRESS ACCESSORIES

Include amplifiers from 3000 to 5000 watts, microphones, transformers, stands, sockets, attenuators, faders, controls, cables, and other items.

Address Dept. CR for booklet on MAYO New and Improved Microphones. Sent FREE.

MAYO INSTRUMENT CORPORATION
281 East 137th St., New York, N. Y.

NEW AND IMPROVED MICROPHONES

test: if the tube is an '01A, this position is 10. The dial of R3 is set at tap No. 10 and slowly turned toward tap No. 1 until a tone is heard in the phones. If the tube is good, it will start oscillating at about 9; if the tube is poor, then the plate voltage must be increased (the tap switch moved closer to 1) in order to make the tube oscillate. Suppose the tube starts to oscillate at tap No. 3, what does it mean? It simply means that the plate voltage must be increased to a relatively high value before oscillation starts: the tube, therefore, is weak.

To guard against inaccuracy, it might be well to tap the tube gently a few times or wait until the tube heats up (in heater-type tubes) before manipulating R3. Repeat the procedure and tap the key switch a few times to be sure everything is normal, especially after just finishing the tester.

No precautions need be taken for a shorted tube since there are no expensive, delicate meters in the circuit to ruin. A shorted tube will not oscillate and may be immediately placed in its proper junk heap.

The Tube Chart

A chart interpreting the readings of R3 is shown. This chart is based on the results laboriously obtained from many tubes of each of the different types listed. As previously cautioned, although any audio transformer will generate an audio note (although at a different tap on R3) it is important to realize that the effectiveness of this chart depends upon its being used with the same apparatus specified in the List of Parts. If parts other than those listed are used, it will be necessary to make another one by noting the readings of R3 with good, weak, and worthless tubes for a particular setting of R2. All readings less than this value should be rejected.

One other point should be considered. It may so happen that a tube made by the "So-and-So Company" will be good at tap No. 9, while a tube just as good, but manufactured by another company, may read O.K. on tap No. 8. This may be due to an unusual filament construction, and a slight adjustment of the chart will take care of this contingency.

In a forthcoming issue of RADIO-CRAFT a similar tester, all A.C. operated, will be described.

List of Parts

- One 10-ohm fixed resistor, 2 watt, R1;
 - One Remler 6-ohm rheostat (with dial), R2;
 - One Remler 1,000-ohm potentiometer, tapped, R3;
 - One .00025-mf. fixed condenser, C;
 - One Acme type VA2, using posts P1, B+4, F6, and G8, A.F.T.;
 - Eight binding posts;
 - One Leeds drilled panel, 5x7 inches, type 330;
 - One Eby 4-prong socket;
 - One Eby 5-prong socket;
 - One Eby 6-prong socket;
 - Two Marko "on-off" switches, SW.1, SW.2;
 - Two H&H S.P.D.T. toggle switches, SW3, SW4;
 - One screen-grid clip and post;
 - One Leeds sub-panel 8x7 inches, and dry-cell holder;
 - Two dry-cells, No. 6;
 - One 4.5-volt "C" battery (used as a "B" battery);
 - One pair telephone receivers;
 - One key (optional).
- Optional: Remler control panel type 330, containing R1, R3, C and the binding posts as standard equipment.

V. T. VOLTMETER

(Continued from page 402)

microhenries, L Cf is the oscillation constant for the fundamental wavelength of the antenna, and Ca is the capacity of the antenna.

The fundamental wavelength of the antenna is found by tuning the calibrated oscillator until maximum indication is had on the V. T. voltmeter, when it is connected across a 5 ohm resistance placed in series with the antenna, at the position of L2, and with the switch on position "A."

Additional Uses

There are many other uses of the V. T. voltmeter. The instrument may be used as the indicating device for bridge measurements (Continued on page 430)

"Years Ahead," Said the Experts. NOW, EVEN BETTER!



RECENT tube developments have made the COMET "All-Wave" (pictured above) and COMET "Pro" (below) Superheterodynes—

even more selective, more sensitive, more stable and easier to tune.

Both receivers now use four "58" tubes, two "57's", one "247" and an "80" rectifier.

The "All-Wave" covers the short-wave and regular broadcast bands, 15 to 550 meters. Console or table model.

The "Pro" globe-trots on the short-waves only—and for proof of unmatched efficiency, here are

SOME USERS

- American Airways
- Eastern Air Transport Co.
- Northwest Airways
- American Radio News Service
- Canadian Government Signal Service
- United States Government, Army and Navy Service
- Key Stations of leading broadcasting networks, for foreign reception—and many more of convincing importance.

The "Pro" may now be had in new style metal or wood cabinet. Battery Model also.

Really GREAT receivers—backed by the 30-year-old Hammarlund reputation for doing things right.

Mail Coupon for Folder

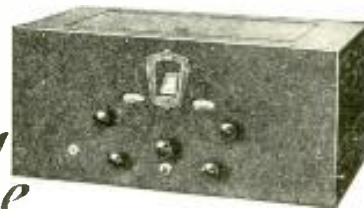

The **COMET** Custom-Built "PRO" by **HAMMARLUND**

HAMMARLUND MFG. CO.
424 W. 33rd St., New York

Please send me illustrated folder, describing the COMET "PRO" and All-Wave Superheterodynes.

Name

RC-133

SERVICING BY THE RESISTANCE METHOD

(Continued from page 411)

Since position No. 6 is provided to measure the resistance between a suppressor grid and the chassis, no reading is taken at this point because V1 does not have such a grid.

Turning the switch to position No. 7, measurement is made of the resistance between one rectifier plate terminal and chassis. This is one-half of the power transformer secondary and field coil and measures 2,700 ohms. Position No. 8 measures the resistance between the other rectifier plate and chassis, which is the other half of the secondary of the power transformer and field coil and naturally also measures 2,700 ohms.

The selector switch is then turned to position 9, in order to measure the resistance between the filament of the rectifier tube and the plate of V1. This value is 58 ohms. This reading gives an important indication that the first R.F. primary is O.K. The measurement at position 4 could not do this, since it included not only the R.F. primary, but other resistors of such proportionately high values that it was impossible to obtain a definite check of the primary resistance.

Position 10 measures the resistance between the filament of the rectifier tube and the grid terminal of the socket under test. In other words, this is the resistance between the screen grid of V1 and the filament of V8. This is R3 and measures 14,300 ohms.

At position 11, it is possible to measure the resistance from the filament of V8 to the cathode of V1. This includes R3 and R4 and measures 22,300 ohms. Positions 12 and 13 are provided to measure resistances from plate to plate and from grid to grid respectively, between any two sockets.

Continuing the test, the left-hand cable remains plugged into the rectifier socket, while the right-hand cable is now plugged into the oscillator-tube socket V2. Starting at position No. 1 of the right-hand selector switch, the same routine is again followed, passing from one position to another and reading the ohmmeter each time in order to check the resistances of the oscillator grid winding, oscillator plate winding, etc. The various readings are all carefully tabulated.

Next the right-hand cable is plugged into the first-detector tube socket V3, then into the I.F. tube socket V4, then into the second-detector tube socket V5, and finally into each of the output-tube sockets V6 and V7. In each case, the selector switch is swung through its various positions and the necessary readings of the ohmmeter are taken.

Resistances such as the primary of the antenna coupler, which cannot be checked from the sockets by the cable plugs, may be measured by means of the test prods connected into the separate jacks provided for this purpose.

By continuing the analysis from socket to socket as indicated above and checking results each time with all available data on the circuit under test, it is possible to locate the defective resistor, coupling transformer or filter condenser in a remarkably short time. Obviously, it takes a long time to give a detailed description of each operation and the reason for performing it, whereas it is possible to plug the cable into a socket and take eleven or twelve readings in less than five minutes by merely rotating the selector switch and regulating the deflection of the ohmmeter.

Even if resistance data and wiring diagrams are not available, it is possible to perform a resistance measurement analysis and locate trouble in a receiver, provided good judgment is combined with a fair amount of practical experience and knowledge. Table No. 1, which gives the average values of different types of winding resistances used in radio receivers, is valuable for reference purposes, where the actual values specified by the set manufacturer are not at hand. As regards bias resistors, etc., it is possible to check these also by referring to tables of tube characteristics. In many cases, the values of such resistors are a matter of common knowledge to the experienced Service Man.

(Continued on following page)

It's
VALUE that
TALKS
TODAY!

OHIOHM FIRST-AID Resistor KIT

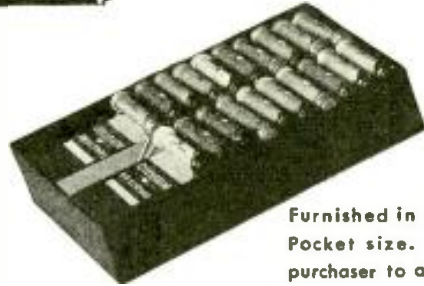

Furnished in two different types. Pocket size. Initial order entitles purchaser to an Ohiohm Resistor

Guide, an Ohm Dial for determining resistance values according to R.M.A. standards, and a supply of attractive service-labels to be placed on back of set after servicing — reminder advertising for the service man.



CHECK RESISTORS for these Cardinal Points:

- Accuracy — resistance value within 10%.
- Permanency—value unchanged by age.
- Absence of noise.
- Low Heat Coefficient.
- Freedom from Capacity Effect.
- Unaffected by Humidity.
- Low Voltage Coefficient.
- Mechanical Strength — ability to withstand rough handling.
- Appearance — straight wire leads, good paint finish, etc.
- Color Coded, Printed Values, Trade-Marked.

WHEN YOU use OHIOHM Protect-O-Packed RESISTORS you are assured that they pass the rigid test of all these points — and more! Nationally advertised, supported with profitable merchandising helps, beautifully packaged. Our booklet, "Sales Resistance Removed from the Resistor Market" tells the entire story. Ask for it. It's free.

SPARK SUPPRESSOR SETS for eliminating Ignition Interference on radios installed in Automobiles

Sets are furnished for 4, 6 and 8 cylinder cars. Furnished complete with Condenser and necessary spark suppressors. The life of an Ohiohm Suppressor is the life of the car.

THE OHIO CARBON CO.

12502 Berea Road Cleveland, O.

OHIOHMS are made in Canada by
C. C. Meredith & Co., Ltd., 67 Bay St., Toronto

OHIOHM
PROTECT-O-PACKED
RESISTORS

Something New
for a NEW MARKET!

Cleanair

ICE-BOX
and REFRIGERATOR
DEODORIZER

● Absorbs and destroys
food odors.

● Prevents blending of
flavors and tainted
foods.

50c
Item

Add this to your line—exceptional profit... Write for facts.

THE OHIO CARBON CO.
CLEVELAND, OHIO

2 GREAT BOOKS THAT WILL BRING YOU MORE MONEY

RADIO PHYSICS COURSE \$3.50
by Ghirardi
Authoritative! Up to the minute! This radio course is published by Ghirardi, Editor of Radio News and a radio instructor of note.
992 pages Over 500 Illustrations

RADIO SERVICING COURSE \$1.50 Postpaid in U.S.
by B. M. Freed and A. A. Ghirardi
Practical! Check full of information and every service man needs in order to keep up to date. 192 pages. Over 100 illustrations. Valuable technical diagrams which every man needs.

MAIL THIS COUPON AT ONCE!

RADIO TECHNICAL PUBLISHING CO., R. C. 1
80 Fifth Avenue, New York, N. Y.
Enclosed find check, cash or money order for copies of Radio Physics Course at \$3.50 each, and copies of the Radio Servicing Course at \$1.50 each. Check here for FREE circular.
NAME
ADDRESS
CITY STATE

Your Copy is Ready

1933 Radio
SETS, TUBES, REPAIRING PARTS, TEST EQUIPMENT, SERVICE MEN'S SERVICES
Allied Radio
1154 Merchandise Mart, Chicago, Ill.

Service Men—Write for your FREE Copy of our 1933 Radio Catalog

LOWEST WHOLESALE PRICES
80 Pages of everything you need in Radio. Complete stocks of the highest quality replacement parts, tubes, test equipment, and accessories at the lowest wholesale prices.

UP-TO-THE-MINUTE SERVICE
Our tremendous stocks and efficient organization are waiting to serve you promptly, courteously, and efficiently.

Write today for your FREE COPY of our 1933 Service Men's Radio Catalog.

ALLIED RADIO CORPORATION
835 W. Jackson Blvd. Chicago

The Capacity Tester

In order to use the capacity tester, the cord with the plug cap is used to connect the microfarad meter to the 60-cycle, A.C. supply line. The two jacks marked MFD permit the use of any range of the microfarad meter independently of the cord and plug. The variable resistor marked MFD above the knob, is used in conjunction with the push-button marked MFD to adjust the microfarad meter to full-scale deflection.

If it is desired to test line voltage, the supply cord from the instrument is plugged into the A.C. outlet. The knob marked MFD is then rotated until the arrow points to 110. The microfarad meter will then indicate approximately 10 mf. The 10 mf. position corresponds to 110 volts and any higher or lower voltage will be indicated by a higher or lower needle position.

The selector switch marked MFD-OFF-OHMS is used to select either the ohmmeter or the microfarad meter, when testing with the two cable and plug connections inserted in the radio set sockets. When using the capacity tester, it is desirable that the condenser under test be disconnected from the radio circuit. However, good results may be obtained leaving the condenser in position without unsoldering it, when testing for open or short circuited condensers. A typical example will make this clear: with a 1 mf. condenser across a grid-bias resistor, the latter is measured for resistance. If the resistance tests O.K., the condenser is not short circuited. Measuring the condenser, a larger reading on the microfarad meter than 1 mf. will show, due to the fact that some current will flow through the resistor and this current will be added to the current flowing through the condenser, giving an abnormally high reading. If the condenser was open, only the current flowing through the resistor would be measured and the reading would be much less.

Conclusion

The above discussion will serve to give a general idea of the procedure involved in servicing by means of resistance measurement. Naturally, it would be impossible to discuss this subject in its entirety in a single article. In applying this system, line voltage should always be checked and tubes should be tested as a matter of course. Furthermore, plate, screen-grid, and grid voltages may be measured, if desired, to supplement the resistance readings. It is well to tabulate all readings, in order to keep the analysis on a systematic basis.

Service Men who have concentrated their efforts on mastering voltage measurement methods of testing, may hesitate to change to a different system. However, it may be stated without fear of contradiction, that a slight amount of effort in learning to apply a versatile resistance tester will be repaid a thousandfold in greater efficiency, and hence in increased profits.

Additional Notes

The resistance values of the choke coils and transformers in this model chassis are shown in parentheses in the diagram (Fig. 1); other constants are given below:

Tuning condensers C1, C2, C3, 18 to 325 mmf.; trimmer condensers C1A, C2A, C3A, 4 to 50 mmf.; oscillator padding condenser C4, 745 mmf.; padding trimmer C5, 15 to 75 mmf.; C6, 745 mmf.; C7, C14, C19, C21.

(Continued on page 437)

LET'S LOOK AT RADIO

PAST, FUTURE AND WHAT IT MEANS TO YOU AS A CAREER

Here you will read why many experienced radio men are adding to their general knowledge at this time . . . or are "Going back to school" to specialize in advanced subjects—and also note their recommendations to fellows ambitious to enter the radio field.

Just to illustrate the advance of radio; 23 years ago men were being instructed at America's only radio school in but one subject—The Maintenance of Marine Radio Equipment. That was all there was to teach in radio!

Today this same school—RCA Institutes—is adding new courses—and new subjects to its older courses—as the march of radio goes on—developing, possessing, advancing!

This school has always had the one major aim: to be of benefit to the radio industry. Tuition costs are kept at a minimum, with privilege of time payments—even as low as \$4 weekly. (Still less in Home Study courses, which include a post-graduate free practical training period.)

Among the thousands of graduates of RCA Institutes are many successful radio men—some high in executive or engineering posts—to whom the first principles of radio were unfolded here. They will tell you that the expert instruction and personal interest they received gave them their start and paved the way toward success.

The renowned father of radio, Marconi, has always had a strong interest in this school, in fact, for many years it bore his name as the "Marconi Institute."

Today . . . whether you are just beginning radio or have an advanced knowledge . . . RCA Institutes offers you the opportunity to cope with practical radio engineering . . . teaches you to enlarge your knowledge. We are at present presenting a new general course in radio, combining Broadcasting . . . Sound Motion Pictures . . . Aircraft Radio . . . Marine Radio . . . Radio Servicing . . . Home and Studio Recording . . . Television Fundamentals . . . Electronic Tube Applications . . . Radio Code . . . Public Address Systems . . . and other radio and allied subjects, which may be taken in whole or in units, as needed.

You may wish to specialize in a particular phase of radio or associated arts, so send for a copy of our illustrated catalog which contains all particulars about RCA Institute's various residence schools and Home Study courses.

Or visit our school in either New York or Chicago. You will find them modern, fully equipped, and ample in scope for the ever growing field of radio. But in the meantime, clip and mail the coupon below . . . it will bring you the latest details. Do it today—before you forget!

RCA INSTITUTES, INC.
A Radio Corporation of America Subsidiary

RCA INSTITUTE

RCA INSTITUTES, Inc., Dept. RT-1
New York School and Headquarters,
75 Varick Street, New York, N. Y.
Chicago School:
1154 Merchandise Mart, Chicago, Ill.

Please send with no obligation to me:

() Full information on the New General Course in Radio. (At New York resident school only.)
() Illustrated catalog and information about specialized resident school courses in radio and allied arts.
() Information about extension courses for study at home, together with illustrated catalog.

Name Age
Address
City State

Your Ad will appear here

SERVICE MEN! IMPROVE YOUR BUSINESS

BY KEEPING YOUR NAME BEFORE YOUR CUSTOMERS EVERY DAY

FRONT

RADIOMINDER

Most people forget the day, the station, the dial number and hour of their favorite programs and will appreciate Radiominder cards with spaces to record such information. They will be kept for the longest time in any home. Give Radiominder cards with your ad printed on to your customers or place a few in every home in your neighborhood and they will constantly remind the people of you and thus think and talk about you.

BACK

There's No Better Way To Make People Think of You Every Day

These cards are far superior to business cards and their cost insignificant considering the benefits you will derive. Trial orders accepted for as little as

100 Radiominders with your Ad of 5 Lines Printed for **\$1.25** Each additional 100 Cards **50c** Postpaid

Card size 3 1/2 x 5 1/2 inches. Ad space 1 x 3 inches. Printed attractively on heavy Golden Rod Bristol Card. Use ink and handprint your copy and mail today with remittance to

ROTH PRESS, 825-A Sutter Ave., Brooklyn, N. Y.

OPERATING NOTES

(Continued from page 413)

current is fed to the plate of the '27 through the resistor rather than through the primary of the A.F. transformer. A condenser serves to keep D.C. from the winding and to couple the A.F. to it. The 70,000-ohm resistor is located under the power supply unit on the lower shelf and is colored red and green. It is desirable to replace it with a somewhat heavier duty unit if a recurrence of the trouble is not wanted.

Another weak spot in these sets is the 1½-megohm resistor used to drop the high voltage to the 3.5 volts (approx.) used on the screen-grid of the detector tube. An open resistor here may prove rather baffling to the Service Man not familiar with the symptoms of this trouble as the voltage concerned is small and the open resistor will cause no noticeable change in the voltage of the other circuits. The symptoms are: (1) inability to carry any volume, choking up on even medium volumes; and (2) general instability and perhaps oscillation. This resistor is located underneath the resistor-board inside the receiver chassis and may be found after turning the chassis upside down so that the controls are toward you. The resistor (red and white) under discussion connects between the second and third lugs counting from back to front on the right hand row of lugs. Remember that the Victor chassis will not work satisfactorily in this position and must be tested in its correct, right-side-up position. Incidentally, we have found that the slightly higher screen-grid voltage afforded by a 1.—megohm resistor in this position seems to help the performance of the set, so we are using the latter size, in the 2-watt type, for our replacements. It is not easy to see why this resistor gives any trouble as it carries an extremely small current and is worked nowhere near its power rating.

The speaker cones of these sets cannot be centered by eye or with gauges. It is necessary to have a strong 60-cycle hum; the cone is then centered until the note is clear and musical, with no rattle at all. This hum is best obtained by disconnecting the control-grid lead to the detector tube.

One of the toughest jobs that the Service Man runs up against is tracing the cause of intermittent or noisy reception due to poor connections in the set. Check by wiggling each terminal and connection as well as wires which lead through shields, etc., with the set in operation, as connections may have only the appearance of being soldered. Remove dust and examine for burrs or flake aluminum on the plates of the tuning condensers.

PHILCO SETS

Several Philco midget "supers" of the 70 series have come in with a complaint of no volume on the low-frequency end of the scale and badly distorted reproduction all over the dial. Careful check of each set and tubes showed no defect, so that the set was re-aligned with no better success. By chance a new tube was placed in the second-detector socket and the trouble immediately vanished. The old tube showed no defect in a standard tube checker and worked quite O. K. in any other '24 socket. The same tube, used as second-detector in a G.E. superheterodyne worked perfectly. I would consider it a freak case but for the fact that the same has been true of each of the several sets that have come in with this trouble.

Try this stunt if you have a Philco 77 (7-tube T.R.F., S.-G. set, 1931 model) that could stand a little more wallop. (Of course, it is assumed that the set is operating O. K., as this will merely boost the normal volume obtainable from the set.) Find the grid-return wire of the second R.F. tube and insert in series with it a resistor of about 1.-megohm; the value is not at all critical and, within certain limits, the higher it is the better. For that matter, substantially the same results may be obtained if the grid is left floating above ground, although we have found that in instances where the insulation is particularly effective in the grid circuit the grid will block. (In the cases that worked satisfactorily there was doubtless a piece of insulating material somewhere that had a low enough resistance to perform the function of the leak; it is best, however, to include the leak and be

(Continued on following page)

TOBE



New Tobe midget condenser for all by-pass circuits. Working voltage—600 volts D.C. Test voltage — 3000 volts D.C. Capacities .001 mfd. to .1 mfd.



By-pass condenser for use in Sparton chassis—available in ¼ mfd., ½ mfd., and 1 mfd. sizes. Standard mountings.



New Tobe dry electrolytic filter condenser for replacement in receivers originally using wet electrolytics. Available in all capacities and combinations of capacities.

THE above trade mark—now placed on the most complete line of by-pass, filter, transmitting, and electrolytic condensers ever offered to the radio industry—is your assurance that the product on which it is placed is correctly designed, carefully constructed, thoroughly tested, and absolutely RIGHT for your radio work.

A few of the most popular items in the new line are shown on this page. For complete information about the entire line, send the coupon below for our latest catalog.



New special service condensers. Specially designed for use in repairing power packs requiring a compact and rugged condenser. Available in capacities from 0.1 mfd. to 2 mfd. Working voltage—400 volts D.C.



New Tobe universal by-pass condenser for replacement in receiver chassis. Available in all capacities and groupings of capacities.



Tobe precision condenser. The old reliable by-pass condenser. Standard since the earliest days of radio.



New Tobe dry electrolytic condenser in cardboard carton. Available in all capacities and combinations of capacities.

TOBE DEUTSCHMANN CORPORATION CANTON, MASSACHUSETTS

Gentlemen:

Please send me your new Condenser catalog number RC-133.

I buy my condensers thru

Signed

Street

City

State



SAMSON
PAM-110
CLASS B AMPLIFIER

HERE IS A REAL PROFIT MAKER

Amplification is now indispensable to many institutions and organizations . . . Be up-to-the-minute and create for yourself a reputation for knowledge and dependable service in handling and installing amplifiers.

This can be assured if you handle SAMSON SOUND EQUIPMENT . . . The PAM-110, for example, is outstanding in its class and thoroughly dependable. . . 26 watts power output with variable output impedance, and designed for operation with the MIK-110 . . . a combined input mixer, input coupling device, and tone modifier, this amplifier offers most power per dollar.

SPECIAL OFFER: Our Bulletin RC3 covers the theoretical and practical uses of Class B Amplification and the complete story of the PAM-110 and the MIK-110. Send stamps, totaling 15c to cover the cost, and address:

R. W. COTTON
Samson Electric Co., Canton, Mass.
Member R.M.A. Mfrs. Since 1882

AERO INTERNATIONAL ALL WAVE 11-TUBE SUPER-HETERODYNE DE LUXE



Completely Assembled
With 2 Matched Full
Dynamic Speakers **\$29.75**

At last! World wide reception at a sane price. 15 to 550 meters. Besides the regular broadcast band, it brings in foreign programs, amateurs, police calls, ships at sea and aeroplanes. One dial control. No plug in coils. Latest super-phonic tubes.

AERO 4-TUBE MIDGET



\$10.95 less tubes
2.95 kit of tubes

The lowest priced quality Midget Receiver on the market today. Very selective, brings in long distance like local stations.

AERO 5-TUBE MIDGET \$11.90
AERO 6-TUBE MIDGET... 18.50

AERO WORLD WIDE



1-Tube SHORT WAVE
\$5.95 SET for Head-
phone Operation

Listen in DIRECT to London, Paris, Berlin, Buenos Aires and other broadcasting stations throughout the world via short waves. Your ordinary receiver cannot tune in these low wave stations. WORLD-WIDE RECEIVER gets 15 to 500 meters. Aero 2-Tube Short Wave Set \$8.75. The same as above set but it has 1 stage of Audio Frequency added to it.

Write for Complete Catalogue.

CHARLES HOODWIN CO.

4240 Lincoln Ave. Dept. A-150 Chicago

safe; we have never found any necessity to by pass it.)

ATWATER KENT

In Atwater Kent's new model 85 receiver a great improvement in the operation of the manual volume control may be had by making a careful selection of the tube used in the A.V.C. socket, which is the '24 socket nearest the rear of the chassis. With some tubes the control is critical, the entire range of volume falling within a fraction of a turn of the knob. Also quite a time lag (a la Kolster 6-J) is noticed. With other tubes the manual control is quite smooth.

(In conclusion I wish to say that I agree absolutely with the correspondent in your September issue concerning "sets that never go wrong"; as the farmer said, viewing the giraffe, "There ain't no sich animule." It is hoped that all manufacturers will soon follow the lead taken by Philco and a few other progressive manufacturers in adopting standard R.M.A. markings so that the values of small parts may be determined even if service notes on that set are not available.

Being a Service Man and an amateur, I would like to know what percentage of Service Men hold amateur licenses. How many feel qualified to answer?)

SHORT CUTS

(Continued from page 414)

IMPROVING T.R.F. SET VOLUME

M. G. Foster

RECENTLY, I had occasion to repair some T.R.F. receivers of the single-dial type. The grid of the first R.F. tube in all cases was connected to the antenna and completed to ground through a choke coil or resistance, as shown in Fig. 4. It was found that by connecting a fixed condenser, of 500 mmf. to .001-mf., from the plate of the first tube, V1, to the second, V2, the volume could be practically doubled without impairing the alignment of the tuned circuits.

AN EMERGENCY SWITCH

Chas. H. Jenkins, Jr.

WHEN sparks suddenly fly around, the rectifier tube gets blue or hot, the pitch compound starts to burn, and things generally go haywire, we have to work fast to open the power line. The manner in which the writer rigged up an emergency circuit-opening switch for use when shorts develop in a receiver under test on the bench is clearly illustrated in Fig. 5. At A is shown the general relation of the parts, and at B is shown a detail of the contact elements of the switch. There are several ways in which a spring may be arranged to maintain an open circuit.

Thus, if something starts to "act up," I have only to remove my foot from the pedal (which is 4 1/2 ft. long) and the power circuit to the equipment under test is immediately opened.

V. T. VOLTMETER

(Continued from page 426)

of all types. The arrow of the microammeter is caused to read midscale by adjusting the bucking circuit comprised of R3 and R5, in the case of the goose-neck V. T. voltmeter. For A.C. measurements where telephones would ordinarily be used, the amplifier terminals of the instrument may be connected in the place of the phones with greater accuracy.

The instrument may be used as an output meter, as the reader can now see from the foregoing description of measurements given in the article.

To use the instrument as a level indicator, the reader will find it necessary to insert an iron core inductance or retard coil in the plate circuit of V2 of the voltmeter, between the plate and the meter. The inductance should have a value of at least 100 henries, and a larger value will be better. This inductance is used to smooth out the action on audio-frequency impulses in order that the arrow of the instrument will maintain a constant, or mean, value for the volume or level of the amplifier to which the indication is applied.

3 New 50c Books



No. 1.
FORMULAS AND RECIPES

For the Practical Man

By S. GERNSBACK

An extremely helpful book showing you how to save money by making in your own home, at a fraction of the regular cost, the hundred and one preparations which you now buy for use at home or business.

PARTIAL CONTENTS:

1. Adhesives; Glues, Cements. 2. Cleansing; Stain Removers, Bleaches. 3. Metal Craft; Coloring, Oxidizing, Plating, Polishes. 4. Paints; Colors, Stains, Varnishes. 5. Glass-Working; Cutting, Drilling, Boring, Etching, Engraving. 6. Wood-Craft; Finishing, Fireproofing, Waterproofing, Furniture Polishes. 7. Inks; Sympathetic, Invisible, Hectograph. 8. Photography; Developers, Emulsions, Fixers. 9. Antidotes for Poisons, Remedies for Burns and Scalds, Disinfectants. 10. Preparation, Manipulation, Handling, Mixing, Tables of Weights and Measures. Useful Tables.

No. 2. FUNDAMENTAL PRINCIPLES OF RADIO
Radio Simply Explained—Its Origin, Nature and Functions

By LOUIS MARTIN



Prepared with special consideration given to young members in the radio profession, and those who have gained their experience in a haphazard fashion. This radio primer is a handy fundamental aid for "checking up" and systematizing your knowledge of radio. Regardless of how much you know about the subject, you should read this book.

PARTIAL CONTENTS:

Chapter I—Fundamentals of Radio: Electricity, Resistance, Batteries, The Magnetic Circuit, The Magnetic Field, Inductance, Condensers, A.C. Circuits, Propagation of Radio Waves; Chapter II—The Simple Radio Set, Single, Two, and Three-Circuit Tuners, The Battery Set, Vacuum Tubes, Electric Sets, Loud Speakers; Chapter III—Diagrams, How to Read Them; Chapter IV—Amateurs and Broadcast Stations, Talking Pictures, Television.

No. 3. ELEMENTARY MATHEMATICS
for the Technician and Craftsman

By C. SHAINMARK

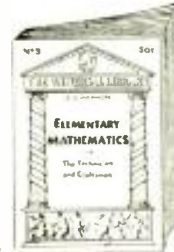

This manual has been especially prepared for the man who wishes to acquire a working knowledge of the elementary principles of mathematics. A complete treatment of the subject is given by the author, Mr. C. Shainmark, with special attention to the use of mathematics in Radio and other technical work for those who employ its formulas daily.

PARTIAL CONTENTS:

I—Arithmetic: Addition, Multiplication, Subtraction, Division, How to Use Decimals; II—Fractions, Percentages, Ratio and Proportion; III—Powers and Roots; IV—The Metric System; V—How to Measure Surfaces and Volumes; VI—Mathematics for the Manual and Technical Craftsman; VII—Special Mathematics for the Radio Technician; VIII—Commercial Calculations, Short-cut Arithmetic, Interest Calculations, Discounts; IX—Weights and Measures; X—Useful Tables.

All our books are of uniform size, 6 x 9 inches, and contain 64 pages. The books are printed on strong paper with stiff colored covers.

PRESS GUILD INC., 16 Murray St., New York N. Y.
Enclosed find \$.....for which mail me postpaid the following books:

No. 1 No. 2 No. 3
50c each. Postpaid.

Name

Address

City and State

SERVICING WITH AN OSCILLATOR

(Continued from page 415)

form a copper ring. With the aid of two bakelite strips the ring was carefully moved up and down until a spot was found where the output meter response was the greatest. A few drops of wax held the ring until it was taped in place. The set was then balanced and worked O.K. Fig. 2 shows the qualitative output curves of the set before, B, and after, A, the change.

Use the following method of balancing: Loosen the set screws that hold the rotor to the condenser shaft (or, run the trimmers out). Turn on the service oscillator and connect a coupling lead to the high-potential post of the service oscillator output. Tune this oscillator to 600 kc. and put the free end of the coupling lead into the last coil (detector stage). Now move the rotor of the condenser which tunes this coil until maximum response is secured on the output meter, and then tighten the screws. Repeat this performance with the other tuned stage. Then go through this procedure at 800, 1,100 and 1,500 kc. Note on paper the readings of each coil, at each frequency. If too great a discrepancy exists between the readings the tuned circuits are mis-matched.

If everything is O. K., retune to 600 kc. on the set and connect a dummy antenna in series with the set input and oscillator output as shown in Fig. 3. The dummy antenna may be made in several ways. For instance, by winding 30 T. of magnet wire (any convenient size) on a tube 1½ in. in dia., and connect in series with this inductance a resistor of 25 to 30 ohms and a condenser of about 250 mmf. This design is efficient for qualitative work of this nature. Now, balance the set in the customary manner by varying the condenser settings at each frequency.

Figure 4 shows some other uses for the oscillator. The headphone wiring of circuit A employs a "uni-lateral" connection. Circuit B is that of a detector connection, which, therefore, is suitable for indicating the relative gain of any type of tube, V. (applying suitable filament potential, etc.). Condenser bank C2 is arranged to peak the tuned circuit at about 225, 400 and 500 meters (exact capacity values will depend upon the individual R.F. transformer). A 2 meg. grid leak and 250 mmf. condenser are used.

If a detailed explanation of the methods shown is wanted, the writer will be glad to supply the information provided a stamped and self-addressed envelope accompanies the query.

RADIO KINKS

(Continued from page 419)

much better than one ordinarily finds in a one tube.

My meters indicate that in this circuit the screen-grid operates at about 55 volts; the plate has a potential of about 30 volts, its value being determined by the setting of R3.

Coil L is the usual three-circuit tuner, with a secondary designed to match the tuning capacity, C1. The other values are as follows: condenser C2, 250 mmf.; C3, any good dual electrolytic condenser, preferably of dry type, 4 mf. per section; CH, two 20 hy. choke coils or A.F. transformer secondaries; T, 2½ v. filament transformer; R1, grid leak, test for best value between 0.1- and 2 meg.; R2, Centralab 0 to ½-meg.; R3, 0 to 25,000 ohms.

The rectified D.C. equals only one-half the input A.C. voltage; this is quite O. K. for the set illustrated. I claim no credit for the rectifier as it was explained quite completely in the December, 1931 and the May and July, 1932 issues of RADIO CRAFT.

MAKE YOUR OWN DRUM DIAL

John D. Hayden, Jr.

FINDING it impossible to obtain a drum-type dial to fit the chassis of a certain receiver, I built one in accordance with the plans shown in Fig. 5. The trick is to use as the rotating disc, a wire-wound rheostat from which has been removed the contact-arm and rod, and the wire-

(Continued on page 434)

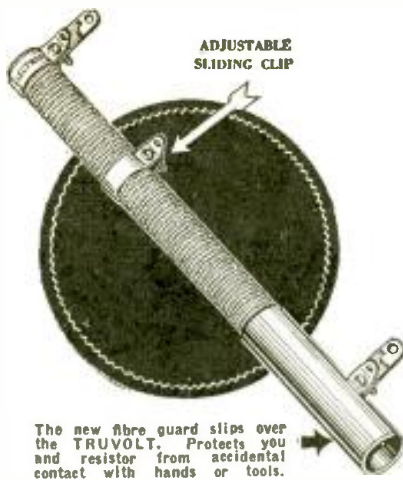

The new fibre guard slips over the TRUVOLT. Protects you and resistor from accidental contact with hands or tools.

Only TRUVOLTS Have These ADVANTAGES

- 1—Patented construction permits air-cooling, larger wire, greater radiation and longer life.
- 2—Spiral winding permits better electrical contact.
- 3—Sliding clips permit accurate adjustment to desired voltages.
- 4—Full-length fibre guard prevents injury from contact with tools or hands.

Replacement VOLUME CONTROLS ALUMINUM Shafts—Snap-on SWITCH

Long ALUMINUM shafts, easily cut to desired length. Standard end cover may be instantly replaced by power-switch assembly, without disturbing control connections. Two new features, which save service time, labor and money.



Plain and switch covers instantly interchangeable. Just snap one out and the other in.

AMPLIFIERS FOR EVERY PURPOSE

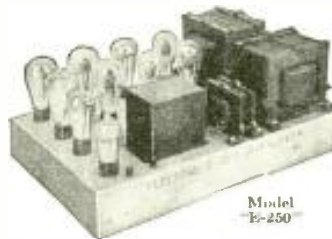

High output, rich tone, economical operation. Four models, delivering from 1.6 watts to 21.9 watts of undistorted power.

Write Dept. RC-1 for Complete Catalog

75 Varick St., New York, N.Y.
ELECTRAD

HERE IS THE IDEAL UNIVERSAL AUTO OR LIGHT SOCKET OPERATION
13 WATT CLASS B AMPLIFIER
CONSUMES 55 WATTS AT FULL LOAD...36 WATTS AT NO-LOAD!
Employs very latest Type Tubes, 1-82 (or 83), 3-46, 1-224A.
Permits Instantaneous Use With either a 6 VOLT STORAGE BATTERY OR FROM A 110-120 Volt 50-60 Cycle A.C. Sock

Its Amazing Low Drain of 55 Watts including all Plate and Filament Current Requirements Permits the use of THIS 6 VOLT AUTO A.C. UNIT producing 115 Volts, 60 Cycles 65 Watts IDEAL for use in any AUTO.

SPECIFICATIONS: Gain at 1000 cycles 85 D.B.; **INPUT:** To Grid of 1st tube; **STAGES:** Three; **OUTPUT:** 10,000 ohms (to Plates of 46 Tubes), 15, 7½, and 3½ ohms; **IUM:** Minus 54 D.B.; **UNDISTORTED PEAK OUTPUT:** 16 Watts; **SIZE:** 13½ in. x 9½ in. x 8¼ in. tall. (Available for 59 Tubes in place of 46 Type, if desired). For 115 Volt, 40-60 cycle A.C. AN IDEAL MICROPHONE, PHONO, and RADIO TUNER P.A. AMPLIFIER!

Available in Kit or FACTORY WIRED Models

MODEL A-76 CLASS "B" AMPLIFIER
(Parts Listed Obtainable Singly if Desired)

1—Cto-C" Drilled Chassis and 3 "Cans" ..	3.65
5—Eby Sub-Panel Sockets ..	.75
1—Cto-C" Class "B" Power Transformer 300-300 Volts, 200 D. C. Milliamperes ..	6.75
2—Cto-C" Filter Chokes (200 ohms, 15 Hy. 120 M. A.) ..	3.90
2—Cto-C" Filter Chokes (500 ohms, 50 m. a.) ..	2.90
1—Cto-C" 888 mfd. Electrolytic Cond ..	1.95
1—Cto-C" Push-Push Class "B" Input Transf. ..	2.95
1—Cto-C" Push-Push Class "B" Output Transf. (15.75 35 ohm secondary) ..	4.05
1—Cto-C" Choke (100 Hy. at 4 M. A.) ..	2.40
1—Cto-C" 1 M. 200 Volt Electrolytic Cond ..	.50
1—Cto-C" 10 M. 25 Volt Electrolytic Cond ..	.50
1—Cto-C" 10 M. 50 Volt Electrolytic Cond ..	.52
1—Cto-C" 02 Mfd. 300 Volt Electrolytic Cond ..	.22
1—Kit of 6 Lynch Metallized Resistors: 750, 10,000, 20,000, 25,000, 250,000, and 1,500 ohms ..	1.20
1—Electrad 500,000 ohm. Poten ..	.60
1—Au-C" Tone Control ..	.65
1—H & H—S. P. D. E. Toggle Switch ..	.23
1—H & H—S. P. S. T. Toggle Switch ..	.20
Misc. Hvd. Wire etc ..	1.75
1—Set of 4 Blue Prints ..	2.00
Total ..	\$38.95
Special Complete Kit Offer ..	\$4.50
FACTORY WIRED MODEL ..	\$39.50
Ready for Immediate Operation ..	\$39.50
Cto-C" 115 Volt, 60 cycle 65 Watt Auto A.C. Power Unit ..	\$27.15
"Mike"—PHONO, Input Transf. ..	2.95
6 Volt JENSEN DYN. SPEAKER ..	8.35
4 Volt R. C. A. DYNAMIC SPEAKER ..	\$15.00
Special Exciter—Permits operation of above 6 volt speakers on 115 Volts A.C. ..	7.95

Write for this Book to day!
YOU CANNOT POSSIBLY AFFORD TO BE WITHOUT THIS VALUABLE BOOK.
It is an 400-Page Encyclopedia of the RADIO INDUSTRY
WHOLESALE PRICES!

COAST-TO-COAST RADIO ACCESSORY CATALOG AND PUBLIC ADDRESS AMPLIFIER SYSTEMS TREATISE

OUR CATALOG LISTS EVERYTHING YOU NEED FOR YOUR RADIO...
We are Manufacturers of CLASS A and B Public Address Amplifiers
Producing Undistorted Outputs Ranging from 4 to 100 Watts
See our Quotations on Complete Single and dual Channel
Sound Track and Semi-Stationary P. A. Installations...
BUY DIRECT FROM THE MANUFACTURER AND SAVE BIG MONEY!

COAST-TO-COAST-RADIO-CORP.
123-R WEST 17th STREET,
NEW YORK, N.Y.

NOW READY

1933 Official Radio Service Manual

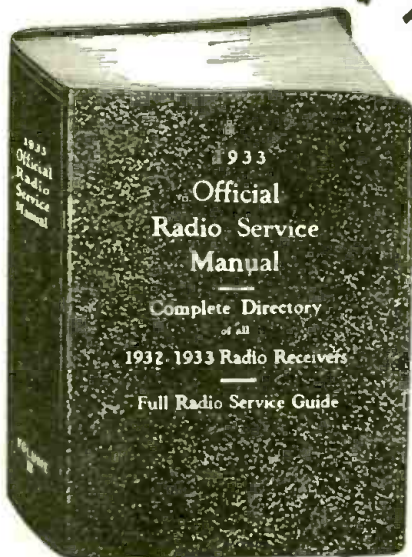

\$5.00

OVER 2,000
ILLUSTRATIONS

OVER 700 PAGES

9 x 12 INCHES

LOOSELEAF FORM

FLEXIBLE LEATHERETTE
COVER

Mail
Coupon
Today!

GERNSBACK PUBLICATIONS, Inc.
96-98 Park Place, New York, N. Y.

I am enclosing herewith my remittance of \$5.00 for which you are to send me one copy of the 1933 OFFICIAL RADIO SERVICE MANUAL at the price of \$5.00 each. Checks or money orders accepted. Register letter if it contains cash or unused U. S. postage stamps.

Name

Address

City..... State..... RC-1-33

THE importance of the last two OFFICIAL RADIO SERVICE MANUALS to those engaged in the Radio Industry has been shown by

the fact that over 52,000 copies of both editions have been purchased and are in use by manufacturers, jobbers, dealers, Service Men and experimenters. Incessant demands have encouraged us to publish this new and bigger *Service Manual* for 1933.

The new manual will not contain so many full-page illustrations as in the past for the reason that not as many new sets are being put out at present, but will have in its contents important information that has not yet appeared in print. This new "dope" is invaluable to radio men. Stress has been emphasized on giving only practical material, not complicated theory. It will save time and money for everyone.

The simplicity in the makeup of the 1933 Manual makes information easy to find, accurately and quickly. As in the past the book will be 9x12 inches, in looseleaf form, with flexible leatherette covers.

Many additional features will be included in the new manual. The FREE QUESTION AND ANSWER SERVICE which was extremely popular in the previous edition will also be maintained. We assure you that the 1933 OFFICIAL RADIO SERVICE MANUAL will be a revelation in radio literature. Orders are now being shipped promptly. Take advantage of \$5.00 price—send your order today. Be among the early ones to get a copy from the first printing. Checks or money orders accepted—register letter if it contains cash or unused U. S. Postage Stamps.

The following are partial contents of the 1933 Manual:

Complete operating notes, and hints from actual experience with radio receivers in the field, collected by practical Service Men all over the country.

Complete actual, pictorial views of hundreds of commercial receivers with additional schematic diagrams. Location of parts on the chassis are shown, and where important adjustments must be made. This section alone is worth the price of the book.

Values of all intermediate frequencies used in superheterodynes, and a complete section of valuable service data on superheterodynes.

Values of resistors and condensers, to aid in replacement work. Latest information on combination long- and short-wave receivers, short-wave adapters and converters.

How to tune and service short-wave receivers for best results.

How to use the most modern servicing instruments.

Complete section showing how the Service Man can build himself service instruments, oscillators, etc., at very low cost.

Complete section on the construction of all test equipment, including high- and low-frequency oscillators, tube checkers, ohmmeters, etc. Tube-chart information on all new and old tubes, in handy form for quick reference; indicating socket connections and operating values, thereby preventing confusion.

An entire section on money-making suggestions for Service Men, written by the Service Men themselves who have made a success of the business; giving you short cuts and commercial information on how to get the most out of the servicing game.

Service information on interference elimination, with practical data and many examples of interference prevention.

Automobile radio installation and servicing—hints on automobile radio in general. Complete data on servicing all known commercial, automobile receivers with short cuts to get quickly at the seat of the trouble.

Service kinks, servicing short cuts, and miscellaneous servicing information. A complete section of various radio tables of every imaginable kind, in constant use by up-to-date Service Men.

A large section giving complete technical data on meters of every kind pertaining to servicing in general.

Complete index and cross-index to make it easy for you to find almost anything pertaining to service instantly.

FREE
QUESTION
AND
ANSWER
SERVICE

In every copy of the 1933 Manual, 24 coupons will be found, which will entitle you to 24 thorough and complete answers by mail on servicing and operating on any of the sets or circuits mentioned in the manual, as well as any others not mentioned, for which you might have need. This service alone is worth \$6.00. But it is absolutely free to manual owners.

THE OFFICIAL RADIO SERVICE MANUAL FOR
1933 COMES TO YOU COMPLETE THIS YEAR

13-WATT, CLASS B AMPLIFIER

(Continued from page 401)

former need only deliver a voltage (one-half the secondary) of but 300 compared to the 600 demanded by the type '50 tubes. This means economy of design and increased efficiency and no more danger of condenser breakdown. The gain of this amplifier is 85 db., and it consumes but 55 watts at full load, and 36 watts at no load. *An equivalent amplifier using '50 tubes consumes 110 watts!*

Mechanical Arrangement of the Amplifier

Figure A shows an external view of the amplifier. As may be seen, the entire power-supply apparatus is completely shielded to prevent stray pickup of hum. The can to the extreme left houses the power transformer; that in the center contains the filter-choke assembly; while the shield to the extreme right houses the filter block and the coupling choke, the latter being mounted at a 45-degree angle in the front. This arrangement of parts assures a minimum of hum; in fact, with the volume control fully turned up the ear must be placed in the cone of the speaker to detect any hum at all!

The five sockets for the tubes are mounted in front where they are easily accessible. From left to right they are the 82 or 83 rectifier (to be discussed later); the next two are for the 59 (or 46) output tubes; the fourth for the 59 (or 46) driver; and the one to the extreme right is for the '24A, the shielded input tube.

All controls for manipulation of the amplifier are mounted in the front, as shown. To the extreme left are three binding posts marked P, B+, P; these connect to the two plates of the 59 (or 46) tubes and the high-voltage line of the output stage. They are intended for connection to the speaker, since some speakers are not equipped with output transformers, the one in the amplifier may be used if desired. Directly under these posts is a toggle switch for turning the A.C. supply to the unit off or on. The tone control is mounted to the right of the ON-OFF switch and posts; further to the right is placed the volume control; and directly to the right of the volume control are the tip jacks for a high-impedance phonograph or input control box output leads and the PHONO-RADIO switch. The right side of the chassis contains another set of tip jacks for RADIO input terminals, and four binding posts at the rear connect to the output transformer in the amplifier. These have provision for 3½-, 7½- and 15-ohm outputs. The chassis layout is now complete.

Technical Details

The schematic circuit of Fig. 1 is complete and self-explanatory. There are, however, a few "kinks" about this amplifier that the builder should remember in deciding upon the best amplifier to use. With the output of the radio set connected as shown, the switch SW. 2 may be thrown so as to connect it with either two or three stages of amplification. In most cases only two will be required, but when phonograph or microphone operation is desired, three stages are preferable. This is the switch marked PHONO-RADIO on the front of the amplifier.

The remaining parts of the circuit are in accord with accepted principles governing class B operation (fully discussed in past issues of RADIO-CRAFT, especially the September number—*Editor*) and require no further comment. It might be well to remind the readers, however, that the usual types of input and output transformers, and power transformers can not be used in any class B system; rigid adherence to the List of Parts must be maintained if good results are to be secured.

Of particular importance is the manner in which the output transformer may be used. Refer to Fig. 2. At A is the output transformer with only one output winding—the 15-ohm secondary. This is shown connected to a single 15-ohm voice coil. This same winding may be used with two 7.5-ohm voice coils in series, as shown at A'; with four 3½-ohm voice coils as indicated at A''; or with four, 15-ohm voice coils as depicted at A'''. The uses of the 7.5-ohm secondary of the output transformer is indicated at B, B', B'', and at B'''. The diagram at C, showing the use of the 3½-ohm secondary, is self-explanatory.

It might also be well to mention the fact that

all RCA Photophone and most horn units have 15-ohm voice coils; the RCA new model, the Jensen 30 watt, the Jensen type D-9, and Western Electric speakers have 7.5-ohm voice coils; the Wright De Costers have .7-ohm voice coils; and the Rola's have 2-ohm coils.

Another interesting feature is the fact that while the amplifier as originally designed is not equipped to handle the field coil of a dynamic speaker, one or more may easily be added by means of the novel switching arrangement depicted in Fig. 3. The point X connects to point "X" in Fig. 1, and point B connects to ground. The coils F represent the field coils of four dynamic speakers (the maximum number that will probably be used with this amplifier), and the resistors, R, are fixed.

Now, if a single field coil having a resistance of 1,000 ohms and requiring 6 to 7 watts for operation is to secure its excitation from the amplifier, then SW. 1 is thrown to position 1, and SW. 2, SW. 3 and SW. 4 are thrown to position 2. This places the field coil in multiple with the output voltage of the rectifier tube, which should be changed to a type 83 in order to supply the additional load. If two dynamic speakers are to be used whose field coils have the rating specified above, then both SW. 1 and SW. 2 are thrown to position 1, while SW. 3 and SW. 4 are kept in position 2; the 83 being used as a rectifier. The same procedure is followed for any number of speakers up to four.

If the rating of the speaker field or fields is 1,000 ohms at 12.5 watts, the 83 rectifier tube must be used in the connection shown in B of Fig. 3. However, if the field rating is 2,500 ohms at 110 volts, the arrangement at B may be used and the 82 rectifier may be retained. In cases where the field has a resistance of 2,500 ohms and requires 6 watts, the parallel arrangement of Fig. 3C will be desirable. Usually, 2,500 ohm, 6-watt speakers will be operated in multiple, hence the arrangement at C. With these three modes of connection, all possible combinations of field coil connections may be used; the voice coil connections were discussed with reference to Fig. 2.

Complete details of the chassis are given in Fig. 4. It may be constructed of sheet iron and then painted black to give a finished appearance. The reference letters on this layout correspond to those given in the schematic circuit and therefore, if the parts specified are used, no difficulty should be found in placing the parts. It will be noted from Fig. A, an under view of the amplifier, that all small condensers and resistors are mounted under the chassis as close to its connecting terminal as possible. In this manner a minimum of holes and complications are avoided.

List of Parts

- One Lynch resistor, 750 ohms, 1 watt, R1;
- One Lynch resistor, 10,000 ohms, 2 watts, R2;
- One Lynch resistor, 20,000 ohms, 2 watts, R3;
- One Lynch resistor, 25,000 ohms, 1 watt, R4;
- One Lynch resistor, 0.25-meg., 1 watt, R5;
- One Lynch resistor, 1,500 ohms for the 46, or 1070 ohms for the 59, 1 watt, R6;
- One Electrad potentiometer, 0 to 0.5-meg., R7;
- One "C-To-C" condenser, 10 mf., 25 V., C1;
- One "C-To-C" condenser, 1 mf., 200 V., C2;
- One "C-To-C" condenser, .02-mf., 300 V., C3;
- One "C-To-C" condenser, triple-8 mf., 500 V., C4, C5, C6;
- One "C-to-C" condenser, 10 mf., 50 V., C7;
- One Coast to Coast type M6515 tone control, V2;
- One Coast to Coast type 6734-A choke coil, 100 hy., 4 ma., T1;
- One Coast to Coast audio transformer type 6769, push-push input transformer, T2;
- One Coast to Coast type 7014-B, push-push output transformer, T3;
- One Coast to Coast type E702 power transformer, 40-60 cycles, 200 ma., PT;
- One Coast to Coast type 6766 filter choke, 15 hy., 120 ma., CH1, CH2;
- One Coast to Coast type 6762 filter choke, 30 hy., 65 ma., CH3, CH4;
- One type '24A socket and tube, V1;
- Three type 59 (or 46) sockets and tubes, V2, V3, V4;
- One type 82 or 83 tube, V5;
- One Coast to Coast type 6109 chassis, black crystalline finished and drilled with three shields.

The Instrument YOU Want



Supreme
one meter
Set Analyzer
Model
56, \$56.25

AT THE PRICE



Supreme
Model 90
Set Analyzer,
\$78.50

YOU CAN AFFORD TO PAY



"The greatest Testing Instrument in History" Supreme Diagonometer AAA 1, 5 ultra modern testing instruments in 1 at the price of 1, \$147.50.

All Prices Dealers Net Price F.O.B. Greenwood, Miss.

That's what the Supreme 1933 Catalog makes clear to every service-man. Over 30 ultra modern service instruments, combinations and kits, and untold parts and accessories, that reach every service-man's purse and give him the guarantee of "Supreme" engineering design. This is "the book of the year" for Radio service and every service-man needs it to plan for profit. It's free!



ASK YOUR JOBBER, SEND THE COUPON

SUPREME INSTRUMENTS CORPORATION,
449 Supreme Bldg., Greenwood, Miss.
Please send me free, without obligation the new
Supreme 1933 Catalog.

Name
Address
City State.....

AT LAST!

A Real
Condenser
Microphone

at a price you
can afford

Model S-2

\$65.00
LIST

Dealers: Write
for Discounts

Comes complete
with 2 stage amplifier
and 25 ft. cord

OUTPERFORMS
ALL CARBON
TYPES

Send for Catalog
on Sound Equip-
ment, Micro-
phones and Acces-
sories



SOUND ENGINEERING CORP.

414 N. Leavitt St.
Chicago

Send your old microphones to us for repairs

**Earn
Big Money**

REPLACE BURNT-OUT
DEFECTIVE BALLASTS

with

CLAROSTAT

LINE BALLAST...

the sure cure for fluctuating line
voltage—easily installed without
the use of tools—foolproof, auto-
matic, and certain in operation;
will outlive the average receiver.

List price \$2.50

FREE! 32 page Clarostat Control
Handbook and Catalog.

CLAROSTAT MFG. CO., INC.

285 N. 6th St.

Brooklyn, N. Y.

The Voltage **"POLICEMAN"**
in Your **RADIO**

There's a world of improvement in
an AMPERITE equipped radio.
Corrects voltage variations, reduces
noise, clarifies tone, protects parts.
Installed in five minutes. If you

do service work, send
\$1.40 to Dept. RC-1 for sample
and profitable sales plan.



AMPERITE Corporation
361 BROADWAY, NEW YORK
AMPERITE
VOLTAGE CONTROL

CRAFTSMAN'S PAGE

(Continued from page 422)

coil design should be given; that is, the number of turns, dimensions of shield-can, etc. I would deem it a great favor if you would let me know the construction data of shielded coils suitable for type '35 tubes when used with a condenser of 350 mmf. Also, similar data concerning a coil of "high-gain" type.

J. BANKS,
"Beronia," Queen St.,
Alexandria, Sydney,
New South Wales.

(It has been a pleasure to hear from you, Mr. Banks, even though we do not agree with your comments concerning purchasing conditions, which do not exist for constructors in "the States.")

It is true that the List of Parts accompanying each article mentions manufactured products, but in nearly every instance, unlike our brothers of the British Isles, the article itself contains construction data for the coils used in the instrument. Or, the coils used may duplicate in design the types described in previous construction stories.

However, realizing that there is considerable interest in this particular topic, articles have been published which cover the fundamental data for building nearly any type of inductance. For instance, the following specific references may be useful: "Design of R. F. Transformers," Sylvan Harris, May, 1931; "How to Figure the R. F. Coil Secondary," Clifford E. Denton, July, 1931; "Short-Wave Inductances and How to Figure Them," Part I, August, 1931, and Part II, September, 1931; "R. F. Coil Design," Part I, (The Secondary), C. W. Palmer, December, 1931, and Part II, (The Primary), March, 1932; "I. F. Coil Design," Clifford E. Denton, April, 1932.

Unless otherwise specified, the voltages applied to the tubes, and the current required by them, in any receiver are those specified in tube tables for normal operation of the particular type of tube used in the individual stages.

Power transformers are discussed in detail in most mail-order catalogs and little difficulty should be experienced in finding a transformer of a given make with characteristics similar to those specified for a unit of different make. Further information on the factors which control the design and construction of power transformers (and choke coils), and their use in a particular set design, are discussed in past issues of RADIO-CRAFT; particular reference is made to the following articles: "The Design of Power Transformers," C. W. Palmer, September, 1931; "How to Construct 46, Class B Apparatus," C. H. W. Nason, September, 1932; "Building Your Own A.F. Choke Coils," C. H. W. Nason, October, 1932.

It may be of interest to note that the construction of R.F. and I.F. coils are illustrated and described in the Information Bureau of the October, 1931 issue of RADIO-CRAFT; untuned R.F. transformers of triode and screen-grid types, in the November, 1932 issue. An "L/C" chart, useful in calculating inductances, appears in the June, 1932 issue. Another useful chart, carrying choke coil design data, appears in the September, 1932 issue.

The particular type of R.F. transformer illustrated in Fig. 1, is made by winding a primary and secondary in the usual manner, with the primary at the low-potential of the secondary, and then winding about one turn of wire (usually, a piece of bus-bar) around the grid or high-potential end of the coil. As shown in the figure, this single turn of wire is dead-ended, and its proximity to the last turn of the secondary determines the degree of uniformity of response over the full wavelength band.—Editor.)

RADIO KINKS

(Continued from page 431)

wound strip which fits edgewise into a semi-circular groove.

Arrange a circle of 3/8-in. wood-screws so that their points protrude through the groove; thus, they will hold well. Wrap and fasten a piece of white paper around the edge of the disc; if desired, it may be marked as a "scale" before it is put on.

A length of 1/4-in. rod is mounted on the panel
(Continued on page 437)

The 1933

OFFICIAL RADIO
SERVICE MANUAL
IS NOW READY

Order your copy TODAY!

See Page 432 of this issue

CHEMISTRY

A New Plan to Become a

TRAINED CHEMIST

\$6.25

By taking only one step at a STARTS YOU time—as your means permit—you can give yourself the benefit of the most complete, thorough-going, up-to-the-minute education for skilled well-paying professional work, in the most fascinating of all scientific fields, through our famous

COURSE IN PRACTICAL CHEMISTRY

Write TODAY For Information

Chemical Institute of New York, Inc.

Founded 1921

HOME EXTENSION DIVISION

19RC Park Place

New York, N. Y.

FORTY IN ONE

Tube Checker
Adapter

List Price \$6.00
Servicemen's Price \$3.75



950 XYL

Tests all the new tubes. Send for catalog—new Analyzer Plugs—

Combination Sockets—Coil Forms—Code Sets, etc. Send 10c for 26 page adapter data sheets, diagrams—connections of new tubes, etc.

Alden Manufacturing Company
Dept. R. Brockton, Mass.

Dial Cables and Carbon Resistors

TRUE FIT DIAL CABLES AND BANDS are made for all sets. Cable can also be obtained on spools.

TRUE WATT CARBON RESISTORS are available in all ohmages from 100 ohms to 10 meg-ohms TRUE WATT RESISTORS are also sold in kits. There is no additional cost for the attractive 20-gauge steel container.

Write today for bulletin RC, showing complete line and discount.

R. J. DUNKLY MFG. CO.

136 Liberty Street,

New York, N. Y.

SERVICEMEN-DEALERS

Send 25c for our Handbook and Catalog
Complete Stock of NEW Radio
Replacement Parts

Hard to Get Parts—We have them. Send us your repair work for estimate.

Grant Radio Laboratories
6521-C South Halsted St., Chicago, Ill.

BOOK BARGAIN

Special Sale of 2000 S. GERNSBACK'S RADIO ENCYCLOPEDIA 1st Edition

WE HAVE on hand 2000 UNBOUND copies of this valuable book, and we are disposing of them at a price which does not even cover the cost of the paper and printing. The books are in first-class condition, sewed and stitched but unbound. You can put a cover on yourself or your bookbinder can do it at a very small expense.

This indispensable radio reference book contains over 1,930 definitions, 519 photo reproductions, drawings, and diagrams. The size of the book is 9 by 12 inches. It contains 168 pages, and is printed on the finest book paper obtainable. Practically every definition in the book is illustrated, and all the subjects are arranged in alphabetical order with numerous tables and charts distributed throughout the text.

SEND NO MONEY NOW!

Do not send any money. We will send you the book and you pay the postman 69c plus postage. Cut out coupon, paste on postal card, and mail to:

ISKOR PRESS, Inc., 19 Park Place,
New York, N. Y.

BARGAIN ORDER BLANK

ISKOR PRESS, Inc., RC-133
19 Park Place,
New York, N. Y.

Please mail me S. Gernsback's Radio Encyclopedia, 1st Edition; Unbound. I will pay Postman 69 plus postage.

Name

Address

City .. State

S.W. RECEIVER DESIGN

(Continued from page 421)

detector; unless a suitable filter is employed in the output, feedback will be present in the I.F. stages and possibly howling in the A.F. amplifier, regardless of shielding or filtering in the I.F. amplifier. A two-section output filter with large chokes, 250 mhy., will generally be suitable.

As this article has covered methods of obtaining the highest possible sensitivity with a minimum of tubes, there is depicted in Fig. 2 a circuit having a total of five tubes, namely: a pentode 58 combination first-detector and oscillator, two 58 I.F. stages, crystal second-detector, a 57 first A.F. amplifier and a 47 power A.F. stage; with the rectifier tube, a 6-tube short-wave receiver. (The same circuit could be used for a broadcast set with only a modification of the coils.)

The antenna is coupled to the first band-selector section through a small midget condenser and is generally adjusted to a low value depending upon the size of the antenna. The two sections of the band-selector should be separated 1 in. to 1½ ins. Choke R.F.C.1 must be a good short-wave type in order that the oscillator may function on all wavelengths.

It should be remembered that the oscillator coils are tuned to one-half of the required frequency. As an example: considering the television and police band of 3,000 to 1,500 kc., the oscillator would tune from 1,750 to 1,000 kc. when the I.F. is 500 kc.; the second-harmonic would be 3,500 to 2,000 kc.

In resistance-coupled A.F. amplifiers, especially high-gain types, motorboating is sometimes very troublesome and filtering is a necessity. However, the "B" connections to the A.F. tubes are such, in the design of Fig. 2, that no trouble will be had from this source.

The writer will be glad to answer any questions concerning this set design, provided a stamped, self-addressed envelope is enclosed.

SERVICE FORUM

(Continued from page 418)

make just one comment—has he actually tried the circuit changes I recommend?

It is true, as Mr. Wiley states, that the output of the set when the changeover has been completed will not be quite as great as before, but a slight circuit change greatly increases the volume; connect resistor R between posts 1 and 5 as shown, dotted, in Fig. 1. The complete diagram of substantially the same set, the Spartan Equasonne model AC-89 receiver, appears on page 279 of the OFFICIAL RADIO SERVICE MANUAL, Vol. 1. Re-balancing the selector unit is necessary.

I might add that the illustration, Fig. 6, in the November issue, does not quite convey the transformer connections, as this unit has only one separate filament voltage other than for the '80 rectifier. The correct change is made by swinging the swivel tap on the top of the transformer from the 120 V. to the 130 V. position.

WALTER McMILLEN,
Tiltonville, Ohio.

A "PAYING" SERVICE BENCH

We have noticed with pleasure that past issues of RADIO CRAFT have contained descriptions of service shops, together with comments concerning their relative value. Perhaps the following comments and description concerning our own shop will be of interest to other Service Men who may want to know whether the service department may be considered profitable.

In the first place, a test panel such as we are using, Fig. A, enables us to give a more complete diagnosis of radio trouble in a shorter period of time than is possible without this equipment, thereby saving the customer time and eliminating all guess work.

At each end of the panel is a recessed compartment in which we can put one complete set of new tubes, for test purposes only, and which also has room to hold the old tubes which are removed from the customer's set. This makes the tubes very convenient and also affords a convenient place to keep the customer's tubes while the set is being repaired.

The panel includes an extremely sensitive output measuring device, grid-dip meters, two ohm-meters giving us a range of ¼-ohm to 10-megohms, a complete set analyzer, a test oscillator, a tube tester, a capacity meter, V. T. voltmeter, short tester, etc. Many of these meters are used for several different purposes and are connected up in various ways to tip-jacks, so that test leads can be plugged into any of the meters at a moment's notice.

In the center part of the bench will be noticed a number of sockets; these are used for tube testing, reactivating, set analyzing, etc.

To briefly explain the accessibility of the panel wiring we will merely state that the reflector at the top of the panel is hinged so that it will fold back and lie flat on top of the panel. Also, the sloping panel on which the meters are mounted is hinged, so that when the reflector is swung back, the panel can be sprung forward to a position parallel with the surface of the bench, where it is stopped by chains at either end of the panel. This makes it easy to make any necessary repairs or changes in our test panel so that it may be kept up to date at all times.

This bench is provided with four large drawers so that we have plenty of room for the many tools necessary in a modern radio repair shop.

We have eight sockets which are "hot" at 110-volts making it very convenient to plug in radio sets to be tested, soldering irons, etc.

You will notice that there are no wires of any kind fastened permanently to this panel. All connections, including aerial and ground, are made by plugging into phone plugs of jacks.

Also we may add, since this picture was taken, we have installed a compressed air system that is brought to the bench through a rubber hose which comes up through the floor at the middle of the bench and hangs by the nozzle between the two center drawers. This makes the compressed air very convenient to use at either end of the bench for blowing the dust out of radio chassis, condenser gangs, etc.

GEO. D. DOTY,
Radio Service & Supply Co.,
403 E. Pike's Peak Ave.,
Colorado Springs, Colo.

You Need This Better Oscillator



Complete with
Output Meter

21%
NET TO
DEALERS
List \$35.00

Readrite

SERVICE TEST Oscillator No. 550

THIS oscillator will enable you to give an unusually fine service—yet it is quoted at an exceptionally low price! It is used to align r.f. gang condensers, locate defective r.f. transformers, adjust i.f. transformers, check oscillator stage, compare gain in tubes and determine the sensitivity of a receiver. Harmonics of the broadcast frequency can be used to check short wave converters and short wave sets. Exceptionally sharp harmonics are obtained.

A Truly Remarkable Instrument at a Remarkable Price

This oscillator is completely shielded and self modulated. Furnished with batteries and one '30 type tube. Covers entire broadcast and intermediate bands. The tuning dial is direct reading for intermediates 120-185 k.c. and 550-1500 k.c. broadcast range. Sharp 2nd and 3rd harmonics cover intermediates 260-262 and 475 k.c.

The oscillator is carefully calibrated at the factory, and the indicator made to track over the entire scale of both bands. In a minute the trimmer condenser can be adjusted and instrument rechecked. If your jobber cannot supply you, we will ship the No. 550 Service Test Oscillator directly to you—when remittance accompanies your order at dealer's net price of \$21.00.

READRITE METER WORKS
33 College Ave., Bluffton, Ohio

MAIL COUPON NOW!

READRITE METER WORKS,
33 College Ave., Bluffton, Ohio.

Gentlemen:

Please send me information about Readrite No. 550 Service Test Oscillator. Also catalog of other servicing instruments.

Name

Street Address

City .. State

EXTRA! JUST OUT —

"BALTIMORE RADIO BULLETIN"

Technical Articles . . . Service Notes
. . . Ham Exchange . . . Ideas, ideas
and more ideas

Sent FREE to dealers and Servicemen
. . . Write to-day

BALTIMORE RADIO CORP.
725C Broadway, N. Y. C.

Quality — KENYON Reliability



KENYON all-purpose amplifier components are the pride of exacting amplifier specialists.

KENYON audio, filter and power transformers may be purchased only from authorized dealers.

Name your favorite jobber and you will receive without any cost detailed schematic diagrams for heavy duty 845-50 watt, 250, 245, 48 D. C. and 46 Class B power amplifiers.

KENYON TRANSFORMER CO., INC.
122-24 Cypress Ave., New York, N. Y.

FREE

13th ANNIVERSARY RADIO CATALOGUE



124 pages containing thousands of the greatest radio and electrical values at real bargain prices

Send for your copy now!

AMERICAN SALES COMPANY
Wholesale Radio Distributors
RC-44 W. 18th St., N. Y. C.

PATENTS—TRADE MARKS

All cases submitted given personal attention by members of the firm.

Information and booklet free

LANCASTER, ALLWINE & ROMMEL

PATENT LAW OFFICES

Suite 437

815 15th St., N. W. Washington, D. C.

Knowledge Pays Big

We teach you how to build and operate Radio Treasure Finders and how to locate Metals Underground. Fascinating, Scientific, Accurate. Full details for 3c stamp — Write TODAY.

Exchange, P.O. Box 607-W El Monte, Calif.

TAU-REX CONVERTS

Any D. C. Milliammeter Into a Sensitive A. C. Meter. A New Copper-Oxide Rectifier—MADE FOR METERS—Size 3/4 in. by 3/4 in. FULLY GUARANTEED.

Can be used in act testers, analyzers and for many other purposes. See Jack Grand's article, "The Specialty Tester" in the November issue of Radio-Craft.

Tau-Rex will be shipped postpaid promptly upon receipt of \$3 (check or money order)—or order, C. O. D. and pay postman. Furnished Complete with Diagrams and Instructions.

Leo Taussig, 3245 37th St., Long Island City, N. Y.

REDUCING MAN-MADE STATIC

(Continued from page 412)

the antenna-ground system. Second, it may enter the set through the 110-volt lighting circuit. Third, if the receiver is not properly shielded, the wiring may pick up a considerable amount of noise. However, if proper shielding is employed, as is prevalent in modern practice, direct pickup on the leads is somewhat remote.

Studies extending over a period of years indicated that the pickup due to the lead-in wire and the ground system are responsible for between 80 and 90% of the noise. Measurements on the direct radiation of interference show that the vertical component of the electrostatic field is, in the majority of cases, at least four times the magnitude of the horizontal component. The data collected also proves that direct radiation of interfering devices drops off very rapidly with distance. Consequently, a large percentage of noise may be kept from entering the receiver if the pickup part of the antenna is located advantageously and the lead-in shielded. The antenna proper should be as high as possible and should be as far as convenient from any wires which might act as conductors of noise. The shielded lead-in, then, is run from this antenna to the receiver. Employing a shielded lead-in, however, placed a capacity of approximately .05 mf. in the case of a 60-ft. lead, across the antenna-ground posts of the receiver with the result that most of the signal picked up is bypassed before it gets to the receiver. Therefore, it is necessary to employ a radio transformer at the antenna end of the lead-in and in some cases at the receiver end as well.

The problem resolves itself to an impedance matching network as shown in Fig. 1, inserted between the antenna proper and the input terminals of receiver. If this net work effects a match of impedances, the transmission loss between the antenna and receiver will be zero, and consequently the output from the set for a given input may be larger than if the network were not employed. The impedance looking into input terminals of the receiver differs a great deal. In some cases L4 is as large as 3 mh., while in others its value is as small as .02-mh. In the former case, the impedance between terminals 7 and 8, when the tuned circuit is at resonance, is about 750 ohms at 1,000 kc., while in the latter case the impedance is only about 5 ohms. It may be shown that an ordinary antenna has an impedance which varies from about 1,500 ohms at 550 kc. to about 400 ohms at 1,500 kc. and is about 800 ohms at 1,000 kc. Therefore, the receiver with high input impedance nearly matches the antenna, and, other factors being equal, will have more output for the same input signal. In such cases the network 3-4 and 5-6 cannot raise signal strength, but in the other cases, making the impedance between 3-4 match 1-2, and making 5-6 match 7-8, the signal may be increased. When the impedance of the receiver is low, the transformer L2, L3 should be omitted for greatest volume. Fig. 2 shows the results of the tests on signal strength with both high and low impedance sets.

The installation of this system of reducing or eliminating interference is relatively simple and practically always effective. The transformer is mounted near the antenna proper and the shielded lead-in is brought down to the receiver where the second transformer is located, provided one is used. The method of grounding and the effectiveness of the grounds has considerable to do with satisfactory operation of the system. A lead from the shield of the lead-in, where it connects to the antenna transformer, should be fastened to a driven ground underneath the antenna, if possible. The shield of the lead-in at the set end should also be grounded to a good ground. Sometimes it is found that considerable noise is picked up on the receiver's ground and that this may be reduced by removing the set's ground and simply connecting it to terminal marked 6 in Fig. 1.

Having thus taken care of the noise on the antenna ground system, let us consider the conduction over the 110-volt lighting circuit.

(Continued on page 437)

Build a TREASURE FINDER!



We supply all Parts for Building Electrical and Radio TREASURE LOCATORS

Radio, Audio, Ground Potential Measurements, Hughes Induction Balances and other types; including Oscillators and amplifying systems.

We supply all materials needed for building and operating any of the recognized treasure finders.

The following standard circuits are described in our bulletin:

- No. 1. Ground Potential, Leap-Frog Method.
- No. 2. Hughes Induction Balance Type A.
- No. 3. Hughes Induction Balance Type B.
- No. 4. Sensitive Hughes Induction Balance.
- No. 5. Simple Super-Sensitive Hughes Balance Circuit.
- No. 6. Radio Frequency Oscillator Circuit.
- No. 7. Audio Oscillator Circuit.
- No. 8. Single Search Coil Hughes Induction Balance with Audio Amplifiers.
- No. 9. Combination Radio Transmitter and Receiver circuit.

Also accessories such as High Frequency Buzzers, Audio Oscillators, Differential Current Transformers, Two Stage Audio Amplifiers, etc.

With any one of these systems you can locate buried treasures, metal war relics, mineral deposits, subterranean water veins, buried gas and water pipes, and lost objects, tools and treasures sunken in water, etc.

Write for pamphlet giving history and theory on this interesting subject. All above circuits and systems are described and explained. List of parts and prices included. (Price of pamphlet 10c.)

Mail Coupon TODAY!

GREN PARK COMPANY Dept. RC
245 Greenwich St., New York, N. Y.

Enclosed find 10c for which kindly send me pamphlet on Treasure Finders.

Name

Address

City

State

1 Volume - RADIO Encyclopedia

Double the size of the
First Edition!

This 2nd Edition, S. Gernsback's Radio Encyclopedia is by far the most useful book in Radio Literature. It is designed for practical use and gives you instant information on everything in Radio.

The fact that 30,000 Radio Men have one or the other edition of S. Gernsback's Radio Encyclopedia in their homes, proves that it is an absolute necessity in the Radio Trade. EVERY RADIO MAN SHOULD OWN THIS VALUABLE VOLUME.

What the New, Second Edition Radio Encyclopedia Gives You

The explanations—or, rather, definitions are not in brief outline form like those of an ordinary dictionary, but they give in fullest detail, and at considerable length, the meaning and application of every word, phrase, general and special term used in the science of radio. Every topic is written in plain, everyday English, easily understood by anyone.

Hundreds of definitions in the book are illustrated by drawings, photographs, diagrams, or charts. Just look up as you would in a dictionary, the word or phrase about which you are seeking information. Every page is key-indexed for convenience and speed in locating any definition. All the subject matter is arranged in alphabetical order.

This greatly enlarged Second Edition Radio Encyclopedia should be used by everyone in radio. It answers all radio questions.—Increases your knowledge and saves time. It covers every known radio problem. It is a gold-mine of facts for every radio man.

2,201 RADIO DEFINITIONS; 1,253
TECHNICAL ILLUSTRATIONS;
34 TABLES AND CHARTS; 24
PAGES OF APPENDIX; Red Mor-
occo-Keratol Flexible Covers;
Printed on strong ledger paper,
loose-leaf arrangement.

NEW SELLING PLAN

In order to allow you to inspect the volume and really appreciate what you are buying, we will send it to you with the privilege of inspection. When the express man brings you the book, look it over. If you like it, pay him the purchase price of the book, plus postage. If you do not like it, just tell the express man to take it back. You won't be out one penny.

352 pages
9x12 inches
Weight 3 lbs.



Mail Coupon for this Book!

S. GERNSBACK CORPORATION,
98 Park Place, New York, N. Y.

RC-133

Send me one copy of the new Second Edition S. Gernsback's Radio Encyclopedia with the privilege of inspection. If I like the volume, I will pay Expressman \$3.98 plus shipping charges.

Name

Address

City

State

SERVICING BY THE RE- SISTANCE METHOD

(Continued from page 428)

0.5 mf.; C8, 1 mf.; C9, 0.1-mf.; C10, C13, 10 to 70 mmf.; C11, C12, 20 to 220 mmf.; C15, .05-mf.; C16, C17, .0024-mf.; C18, 4 mf. (electrolytic); C20, 10 mf. (electrolytic).

Volume-control resistor R1, 3,800 ohms; R2, 150 ohms; R3, 14,300 ohms; R4, 8,000 ohms; R5, 6,000 ohms; R6, 10,000 ohms; R7, 1 meg.; R8, 30,000 ohms; R9, tone control, 0.5-meg.; R10, R11, 0.1-meg.; R12, 40,000 ohms.

Operating voltages in this chassis are as follows (volume control at minimum): All filament potentials except V8: 2.4 volts. Cathode potentials: V1, V2, V4, 40 volts; V3, 8 volts; V5, 25 volts. Control grid potentials: V1, V4, 40 volts; V2, 0 volts; V3, 7 volts; V5, 5 volts; V6, V7, 30 volts (note that the readings of V5, V6, V7 are taken through units of high resistance, and therefore are not the effective values). Screen-grid potentials: V1, V4, 55 volts; V2, 90 volts. Plate potentials: V1, V4, 200 volts; V2, 50 volts; V3, 240 volts; V5, 220 volts; V6, V7, 245 volts. Plate currents: V1, V4, 0 ma.; V2, 4 ma.; V3, V5, 0.5-ma.; V6, V7, 30 ma. Screen-grid currents: V1, V4, 0 ma.; V3, 0.25-ma.

With the volume control in maximum position: Cathode potentials: V1, V4, 3.5 volts; V2, 2.5 volts; V5, 25 volts. Control-grid potentials: V1, V4, 3.5 volts; V2, 0 volts; V3, V5, 5 volts; V6, V7, 30 volts (indicated). Screen-grid potentials: V1, V3, V4, 70 volts. Plate potentials: V1, V4, 240 volts; V2, 65 volts; V3, 235 volts; V5, 220 volts; V6, V7, 245 volts. Plate currents: V1, V4, 5 ma.; V2, 5.5 ma.; V3, V5, 0.5-ma. Screen-grid currents: V1, V4, 0.7-ma.; V3, 0.25-ma. (these last values may be higher or lower, depending upon the age of the tube).

The field coil is electrically center-tapped to obtain one-half the 100-volt drop across it as "C" bias for the power tubes.

RADIO KINKS

(Continued from page 434)

by means of an inductance-switch bushing. Two collars with lock-screws are slid onto it and fastened in position. To these is fastened one end of the piece of strong fishline which is to be looped around one of the screws in the disc and then over the remaining screws and down to the other collar. A spring takes up slack and jars. Mail-order houses will supply escutchcons; or, the experimenter may choose to design his own.

STATIC

(Continued from page 436)

This path is sometimes of paramount importance while in other cases it is relatively negligible. Much depends upon the construction of the receiver and the impedance of the lighting circuit. If the 110-volt lead runs close to plate or other high-potential connections within the receiver, considerable interference usually results. Then, if a 110-volt line which has a very high impedance to R. F. current is coupled to this, it is essential to filter out the noise before it enters the set. Special filters are always effective in eliminating this source of trouble. These consist of a series of chokes and condensers and are so constructed that the 110-volt circuit of the set is plugged directly into the filter and a lead from the filter plugged into the light circuit. The only other connection is to a good ground.

Thousands of filters of this type have already been installed and their effectiveness in reducing interference range from complete elimination to 75% reduction in noise.

The fundamental principles upon which the system is based are sound and it is hoped that many homes will take advantage of this device.

(This article by Mr. Browning is especially interesting in view of the articles published in this magazine on impedance matching. They appeared in our May, June (page 727), and August issues.—Editor.)

Test all the NEW TUBES

with RADIO CITY Products

"DEPENDABLE" TUBE TESTER

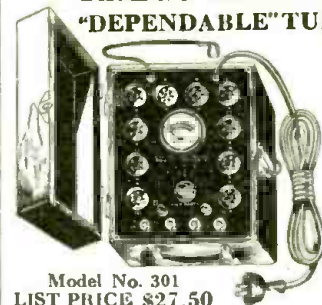

Model No. 301
LIST PRICE \$27.50

Net to dealer or
serviceman

\$14.50

The most remarkable value for the money in a modern and efficient tube checker. Tests all of the new 6 and 7 prong tubes without adapters as well as the new and old 4 and 5 prong tubes. Features include 2nd plate tests for rectifiers, "grid shift" test, "short and gas" test, and line voltage adjustment for 105-115-125 volts. Filament and heater voltages of 1.5-2.0-2.5-3.3-5.0-6.3 and 7.5 are available for any of the ten sockets on the panel. Finely finished case with removable hinged cover for both counter and portable use. Complete instructions and free tube testing information service coupon included.

The New Radio City MULTIADAPTER

Model No. 204 (with cable and plug). List price \$5.00.
Net to dealer or
serviceman. . . . \$2.95

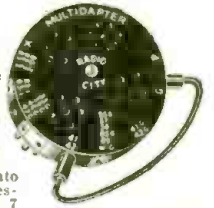

Universal type—fits all tube checkers, analyzers, etc.—combines all individual adapters into one—provides for testing all present and future 4, 5, 6 and 7 prong tubes—provides for many miscellaneous circuit tests. More than 50 different types of tubes may be tested in the Multiadapter with your present equipment.

MULTIADAPTER Model No. 203 (UY prongs in base—no cord or plug). List price \$4.50.
Net price to dealer or serviceman . . . \$2.75

Radio City Voltmeters and Milliammeters. Moving coil d'Arsonval type—1000 ohm per volt sensitivity. High grade instruments at revolutionary low prices.

Write for
descriptive bulletins of Radio City Products
RADIO CITY PRODUCTS CO.
48 West Broadway New York, N. Y.

BACK ISSUES of RADIO-CRAFT can be had at the price of 25c each. Address RADIO-CRAFT, 98 Park Place, New York City.

SERVICEMEN! DEALERS! YOUR PROFIT GUIDE FREE! EVERYTHING NEW!



Send for your copy of the New Radolek Profit Guide to-day! Hundreds of new items at lowest wholesale prices makes Radio Servicing easier and more profitable. Dealers, Servicemen, Laboratory Heads and Manufacturers send coupon below with your letterhead or business card for free copy.

THE RADOLEK COMPANY
601 W. RANDOLPH ST.
CHICAGO, ILL.
Phone MONROE 5434

The RADOLEK CO., 120 Canal Station, Chicago, Ill.
Send Me the New Radolek Profit Guide

Name

Address

City..... State.....

Do you do service work? Yes. No.
Do you operate from Store, Shop or Home?
 Store or Shop. Home.
What Testine Equipment have you?

What Training Course or experience?

**Here is the
INSTRUMENT
you have been waiting for!
The E33 Tube Checker**

Modern in performance—Moderate in price. Tests all tubes without adapters, 1, 5, 6 and 7 prong, giving Short Test; Grid Change Test; Oscillation Test and Total Filament Emission Test. Voltage regulation 90-130 volts. Nine sockets, and selector switch gives flexibility that takes care of all present and future type tubes. Simple to operate—Material and workmanship guaranteed. Lettered back plate—Imitation leather carrying case with handle provided—Light and portable.



**ONLY
\$19.80**

Send your tube checker problem today by mailing Money Order or Certified Check for \$19.80 to

L. & L. ELECTRIC COMPANY
336 Madison Ave. Memphis, Tenn.

**RADIO'S NEWEST
AND GREATEST
FUNMAKER**

Hear your own voice out of the loud speaker of your own radio. Impersonate radio favorites. Interrupt radio programs with announcements and witty remarks. Surprise and mystify your friends. Develop your radio talent. **LITTLE WONDER "MIKE"** is the **GREATEST RADIO SENSATION OF THE YEAR**. Easily attached to your radio. Simply push the button—off goes the regular program—and the fun begins. Something entirely new for home entertainment. A Riot of Fun. Mailed postpaid for only \$1.00.



WONDER SPECIALTIES, INC.
114 C. A. C. Bldg. Cleveland, Ohio



**LITTLE WONDER
MICROPHONE**

MIDGETS

Mr. Serviceman and Dealer

Midgets of High Quality

- 4 Tube 2 Circuit with tubes.....\$11.00
- 5 Tube 3 Circuit with tubes..... 13.00
- 5 Tube Super with tubes..... 15.50

110 Volt, 60 Cycle, A.C.

Regular 90 day guarantee including tubes

TRUMAN RADIO SHOP
7443-C Stewart Ave. Chicago, Ill.

**Study RADIO in
CANADA**

A start in Radio Guaranteed or your money back. Course covers Radio, Television, Sound Amplification and Telegraphy. Practical work material supplied. Preparation for Government and Service examinations. Home Study, Day or Evening Classes. Write for booklet.

RADIO COLLEGE of CANADA
Limited

310 Yonge Street Toronto, Canada

SERVICE MEN!

Dumont Electrolytic and Paper Condensers are acknowledged best for replacement work. 20 years manufacturing experience behind products. New and revolutionary static and aerial eliminator. LIST PRICE \$5.00. Write for free catalog and prices. **DUMONT ELECTRIC MFG. CORP.**, 453 Broome St., New York, N. Y.

NEW TUBE ANNOUNCEMENTS

(Continued from page 399)

(2) Second detector, where pentode characteristics and self-bias may be used to extend detector operating range by permitting increased output voltages to be obtained.

(3) In any circuit where self-bias or a separate cathode connection is of importance.

In the design of this tube the smallest cathode which can be handled in production has been selected. The diameater is just large enough to permit a coated "V" filament to be inserted, this forming the heater. With this design, the tube can be used on A.C. if desired, without the introduction of appreciable hum.

The heater power required has been reduced to 20% of the amount taken by the efficient, 6.3-volt cathode used in the '36, '37 and 44 type tubes, and is only .45-watt. The average heater-current required is approximately .2-ampere, or somewhat more than three times that taken by the '32.

The type 15, Fig. B, tube utilizes the standard, five-pin base, the connections for which are shown in Fig. 6.

The following rating and characteristics obtain:

Heater voltage, 2; heater current, .215-ampere; plate voltage, 135; screen voltage, 67.5; grid bias—1.5 volts; amplification factor 782; plate resistance, 1.25 megohms; mutual conductance, 625 micromhos; plate current, 1.85 ma.; screen current, .6-ma.

For those anticipating the use of this tube in short-wave receivers, the following inter-electrode capacitances are given:

Effective plate capacitance, .01-mmf.; input capacitance, 2.35 mmf.; output capacitance, 7.8 mmf.

Type 19, Class B Amplifier

From the standpoint of economy, a class B connection is expensive because it requires the use of two tubes. Sylvania has solved this problem by designing a single tube which in itself constitutes a class B amplifier. This tube fills the need for a high output, class B combination in the 2-volt group which heretofore has been met to a limited extent by employing two type '30 tubes biased to cut-off. Under these conditions, approximately 22 volts is required for bias, making it necessary to employ a total of 180 volts of "B" battery, which is not desirable from the standpoint of cost. The Sylvania type 19 requires from 0 to 6 volts bias, depending on the applied voltage and the desired no signal plate current drain of the receiver. With only 135 volts applied to the plates, more power is delivered by this tube than is obtained from a pair of '30's operating with 157.5 volts on the plate. The filament employed in the type 19 is of the oxide-coated type and requires .26-ma. at 2 volts. This is the same drain as required by a single '33, while the power output is much greater. Furthermore, the total distortion with the 19 will be less than 5%, while the third harmonic distortion alone in the '33 exceeds this value.

As a class B tube, the type 19 may be operated with 135 volts on the plate. If additional power is required, as much as 185 volts may be supplied. With 100 milli-watts of input power, 1.6 watts will be delivered to the speaker. To secure more power, it is not recommended that the voltage of the driver tube be increased above 180 since the detector tube cannot deliver enough voltage to operate the driver at maximum power output. An additional audio amplifier stage will therefore be required.

The type 19 utilizes a small six pin base, illustrated in Fig. 7. An examination of this diagram reveals the internal arrangement which is further depicted in Fig. 8. It will be seen that only two filament terminals are required, while the tube is arranged with two separate plates and two separate grids, as shown in Fig. 8. Thus, this single tube really constitutes two tubes in one—a complete class B amplifier.

The following ratings and characteristics of this tube, illustrated in Fig. C, obtain:

Filament voltage, 2; filament current, .26-ampere; plate voltage, 135; grid voltage, 0, —3, —6 volts; plate current (no signal), 10, 4, 1, ma.; plate current with a signal of 50 volts

**The TRANSMITTER UNIT
with 100 Uses ~ 95c**

**The Skinderviken
Microphone Button**



**MAKE YOUR OWN
LAPEL MIKE**

OTHER USES:

- RADIO AMPLIFIER
- DETECTOGRAPH
- (Dictograph)
- STETHOSCOPE
- PHONOGRAPH AMPLIFIER
- TELEPHONE AMPLIFIER
- LOUD SPEAKER AMPLIFIER
- CRYSTAL SET AMPLIFIER
- HOME RECORDING OUTFITS

One Unit 95c; two for \$1.75
12-PAGE INSTRUCTION BOOKLET
containing suggestions and diagrams for innumerable uses, furnished with each Skinderviken Button.

This is the smallest microphone made, measuring only 3/4 inches in diameter. It is filled with the finest polished carbon grains obtainable.

—ULTRA SENSITIVE—

EVERY AMATEUR SHOULD HAVE TWO OR THREE OF THESE MICROPHONE AMPLIFIERS IN HIS LABORATORY

SEND NO MONEY

When the postman delivers your order you pay him for whatever you have ordered, plus postage.

PRESS GUILD, Inc. RC-133
16 Murray St., New York, N. Y.

Please mail me at once as many of the following Skinderviken Microphone Buttons as I have indicated.

- One for 95c; Two for \$1.75;
- Three for \$2.50 Four for \$3.20

I will pay the postman the cost of the items as specified. Plus postage.

Name

Address

City State

**SERVICEMEN
RADIO DEALERS**

SEND FOR THIS

**FREE 116
PAGE
CATALOG!**



IT'S CHOCK-FULL

OF BARGAINS FOR YOU

Radio Dealers and Servicemen can't afford to be without this book. It offers marvelous buys in Radio Sets, Long and Short Wave Apparatus, Servicemen's Repair and Replacement Parts, Electrical Goods, Sporting Goods.

JUST OFF THE PRESS!

Be among the first to have the pick of great bargains. Mail this coupon now!

RADIO CIRCULAR CO., INC.
225 Varick St.
New York, N. Y.

Dept. RC.

Please send me free of charge and without obligation, your latest catalog.

Name

Address

City..... State.....

CLASSIFIED ADVERTISEMENTS

Advertisements in this section are inserted at the cost of ten cents per word for each insertion—name, initials and address each count as one word. Cash should accompany all classified advertisements, unless placed by a recognized advertising agency. No less than ten words are accepted. Advertisers for the February, 1933 issue should be received not later than December 9th.

CHEMISTRY

BECOME A TRAINED CHEMIST. Thousands of opportunities—fascinating career. Learn at home. Complete experimental laboratory outfit given. Write for big free book. Chemical Institute, 19 Park Place, Dept. RC, New York.

DOGS

BEAUTIFUL Registered bull pups, \$15. Bull-dogs. 501-RC, Rockwood, Dallas, Texas.

INVENTORS

PATENT YOUR INVENTION: Send for FREE book, "How to Obtain a Patent," and "Record of Invention" blank. Ask us about how to protect your ideas. Deferred payment. Victor J. Evans & Co., 620AA Victor Bldg., Washington, D. C.

RADIO

GUARANTEED MICROPHONE REPAIRS—Any make or model—24 hours service. Stretched diaphragm double button repairs, \$7.50. Others, \$3.00. Single button repairs, \$1.50. Write for 1933 Catalog with diagrams. Universal Microphone Co., Ltd., Inglewood, Calif.

TRANSFORMERS REWOUND, varnished, baked, guaranteed, reasonable cost. **SPEAKER REPAIRING,** magnetic \$2.00-\$2.50; dynamic, voice coils, fields, etc., reasonable charges. Clark Bros. Radio Co., Albia, Iowa.

RADIO Service Men Attention—Power transformers, rewind or rebuilt, to your requirements. Meyke Radio Service, 2624 Margaretta, Maplewood, Mo.

GUARANTEED "Pocket Radio," \$2.00. Catalog, 10c. Neil Tasker, Shamokin, Pa.

In ST. LOUIS



THE AMERICAN HOTEL
275 ROOMS
WITH BATH
\$2.00 up



THE ANNEX
226 ROOMS
WITH BATH
\$1.50 up

The
AMERICAN HOTEL
MARKET AT SEVENTH

The
AMERICAN ANNEX
MARKET AT SIXTH

*Our food has made
our Reputation*
COFFEE SHOP OPEN
UNTIL MIDNIGHT

on the grid, 27, 25, 22, ma.; input power required, 175, 130, 95 milli-watts; average power output, 2.1, 1.9, 1.6 watts; load resistance, plate to plate, 10,000, 10,000, 10,000 ohms.

KR-1 Mercury Vapor Rectifier

The advent of the automobile "B" battery eliminator created a demand for a new rectifier tube. To fulfill this demand a mercury-vapor rectifier was developed in the Ken-Rad engineering department.

The KR-1, shown in Fig. D, is a half-wave, mercury-vapor rectifier tube of the hot cathode type using an indirect heater construction and having the characteristics given below. By referring to this data it may be seen that the KR-1 has been added to the present six-volt family of tubes. Like the rest of that group, it is enclosed in a small bulb and uses a small base, thus making it particularly advantageous for use in automobile and aircraft service where small size is an important feature. The tube has a rugged construction that will withstand the hard service to which it might be subjected.

The primary consideration in the development of a tube for the particular application in this case was the need of high efficiency, a requirement brought about because of the additional burden to be placed on the automobile battery. The only rectifier in common use for receiving circuits when the KR-1 was developed was the UX-280, a tube that could not meet the requirements demanded: first, because of its high filament current; second, because of its high internal voltage drop due to being a thermionic rectifier; and third, because of several inherent disadvantages such as large size, filament type construction, etc. In view of the high efficiency required, a mercury-vapor rectifier was developed. The ionized mercury vapor neutralizes the space charge and reduces the voltage drop to approximately 15 volts. This voltage drop remains practically constant for any load within the limit given in the tube rating, and gives the KR-1 excellent voltage regulation. The low drop makes possible a very high operating efficiency. Like other mercury vapor tubes, the KR-1 has a characteristic pale blue glow which may be seen inside the plate when in operation.

The increase in efficiency brought about by the use of mercury vapor makes possible a low filament consumption, the filament power being 1.89 for the KR-1 against 10 watts for the 280. However, ample output for all normal requirements may be obtained from the KR-1 rectifier.

The isolated heater construction is advantageous from the standpoint that it makes the tube independent of the car battery connections. A rectifier tube of the filament type construction would be impractical in any of the present automobile eliminators because it is desirable that the cathode of the rectifier tube be above ground potential by the amount of output voltage, thus the only practical manner in which the filament-type rectifier could be used would be to take the filament supply voltage from a tap on the secondary winding of the step-up transformer, and in so doing, the filament power would necessarily pass through the points of the vibrator, a very undesirable condition.

In some of the early tests made on the KR-1 tube in vibrator type eliminators, it was noticed that there was considerable sparking between the stem leads in the tube. The sparking occurred during the time in which the tube was warming up to the point at which ionization of the mercury vapor occurred. During this time, the peak voltages were directly across the stem leads. Measurements proved the inverse peaks to be abnormally high. The results of these tests immediately brought about a specially designed stem which eliminated the sparking between leads.

The KR-1 operates satisfactorily under the strain of peak voltage caused by the peculiar wave form in these eliminators and very good life test results have been obtained.

The following rating and characteristics obtain:

Heater voltage 6.3; heater current .3-ampere; max. A.C. voltage, 350; max. peak inverse voltage, 500; max. D.C. output current (cont.) 50 ma.; max. peak plate current, 200 ma.; tube voltage drop (approx.), 15 volts.

TRAIN WITH R.T.A. TO BE A

Professional RADIO MAN

THE TINKERER'S DAY IS DONE!

It's easy that you become a Radio technician through R. T. A. teaching NOW! New, complicated circuits . . . new tubes . . . the approach of popular television . . . all require professional service men. Their future is secure—their opportunities to make good money are unlimited. And R. T. A. can place you in their ranks quickly—easily—and surely through interesting home study that's understood by anyone who can read English.

SET ANALYZER— AT NO EXTRA COST

Included with R. T. A. Training is this excellent set analyzer and trouble shooter. After a few lessons you will know how to use it, and it becomes an immediate means of earning as you learn. Many R. T. A. students make far more than enough to pay for their training by spare time service work, using this analyzer. In addition, R. T. A. gives you life membership in a great radio service men's association with the privilege of consultation on "tough" problems at any time, and an employment service that works to keep you at work.



WONDERFUL OPPORTUNITIES NOW!

You don't have to wait for a dim and distant future as an R. T. A. professional Radio Technician. Even though there was never another receiver built—even though all the tremendous progress in this gigantic industry stopped—there would be enough work in conditioning and reconditioning the sets now in operation to assure you a good living. Look into this great field of professional radio service work. Learn, too, of the many other glowing opportunities open to true Radio-technicians in this field. Fill out and mail the coupon—it will bring you FACTS that will surprise you—and that may open up for you a permanent way out of depression and job-fear.

FILL IN MAIL TODAY

RADIO TRAINING ASS'N. OF AMERICA,
Dep't. R 1, 4513 Ravenswood Ave., Chicago, Ill.
Send me the FACTS about R. T. A. professional training, together with information about the opportunities in the radio service field, without obligation to me.

NAME,

ADDRESS,

SHALLCROSS

No. 651

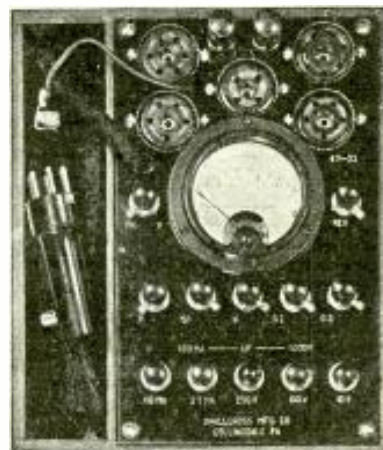

RADIO SET TESTER

For 4-, 5-, 6- and 7-prong tubes

This new circuit makes it possible for the service man to construct a light weight and compact, up to date radio set tester for all tubes and radio sets in general use. It uses a special set of Shallcross Super Akra-Ohm W.re-Wound Resistors.

Send 6c in stamps for Bulletin 161-P containing wiring diagram, construction details, and operating chart.

SUPER AKRA-OHM RESISTORS

Shallcross Mfg. Company

ELECTRICAL SPECIALTIES
700 PARK AVENUE
Collingdale, Pa.

RESISTORS

TRADE NAMES AND MODEL NUMBERS

(Continued from page 405)

6 tube	
A.C. Super.....Sussex.....1590....Midget Cab.	
7 tube	
A.C. Allwave sup...Roland.....1584 Midget Cab.	
7 tube	
A.C. Allwave sup...Warwick.....1586....Console Cab.	
9 tube	
A.C. Allwave sup...Cromwell.....1630....Console Cab.	
12 tube	
A.C. Allwave sup...Alexander.....1640....Console Cab.	
10 tube	
A.C. Super.....1650....Console Cab.	
12 tube	
A.C. Super.....1652....Console Cab.	
6 tube	
A.C. Super.....Adrian.....1592...Console Cab.	

THE SIMPLEX RADIO COMPANY Trade Name: SIMPLEX

<i>Designation of chassis</i>	<i>Designation of complete set</i>
Model P.....Super	
Model P-DC.....Super	
Model P-Battery.....Super	
Model R.....T.R.F.	
Model R-DC.....T.R.F.	
Model S.....T.R.F. All wave	

THE SPARKS-WITHINGTON COMPANY Trade Name: SPARTON

<i>Designation of chassis</i>	<i>Designation of complete set</i>
Model 16-AW.....Sparton Multi-Wave Receiver	
Model 26-AW.....Sparton Multi-Wave Receiver	
Model 28.....Sparton Triolian	
Model 45.....Sparton Visionola	
Model 60.....Short Wave Converter	
Model 99.....Sparks Ensemble	
Model 101.....Sparks Ensemble	
Model 103.....DeLuxe Ensemble	
Model 109.....DeLuxe Model 109	

Model 110.....DeLuxe Model 110	
Model 410.....Sparton Junior	
Model 420.....Sparton Jewel	

STEWART-WARNER CORP. Trade Name: STEWART-WARNER

<i>Designation of chassis</i>	<i>Designation of complete set</i>	<i>Alternative designations</i>
104A.....	40-A.....	Apartment Model
104A.....	43-A.....	Leader Console, without converter
104 & 301		
Short Wave chassis.....	44-A.....	Leader Console with converter
104A.....	45-A.....	Standard Console without converter
104 & 301		
Short Wave chassis.....	46-A.....	Standard Console with converter
104A.....	47-A.....	Portable Console without converter
104A & 301		
Short Wave chassis.....	48-A.....	Radio-Phonograph Combination
105A.....	50-A.....	Master All Wave Console
105A.....	51-A.....	DeLuxe All Wave Console
105A.....	58-A.....	Radio-Phonograph Combination

TRANS. CORP. OF AMERICA Trade Name: CLARION

Sets have numbers only. Model is designated by a label or sticker in cabinet, except 160C and 260C replacement chassis for modernizing old sets. 60 cycle sets are marked, for example, "AC-60"; the 25 cycle set would be "25-60".

UNITED AMERICAN BOSCH CORP. Trade Name: AMERICAN BOSCH

<i>Designation of chassis</i>	<i>Name</i>	<i>Alternative designations</i>
Model 16.....	Amborola	
Model 27.....	Amborada	
Model 35.....	Cruiser.....	Imperial Cruiser Royal Cruiser

Model 66, 76.....	Cruiser
Model 46, 126.....	Little Six
Model 5.....	Personal
Model 84.....	Cruiser.....(Marine Receiver)
Model 100.....	9.20 Motor Car Receiver
Model 200.....	Personal Chest
Models 200, 205, 236, 242, 250, 260, 312.....	Vibro Power

Note: Above are only sets having names. All others have model numbers only. When the same chassis is used in different cabinets the model number is never changed but a letter is added as cabinet designation—200A, 200B, etc.

WELLS-GARDNER & COMPANY

Trade Name: Regular trade name is Wells-Gardner but all receivers are supplied under private stencils such as Arcadia, Airline, Truetone, Fear-nola, Mayola, Hudson, Gt. Northern, Coronada, Granada, LaFayette

<i>Designation of chassis</i>	<i>Designation of complete set</i>
052 5-tube.....	2522 Mantel
AC Super.....	2525 Console
	1520 Mantel
572 7-tube.....	7721 Mantel
AC Super.....	7725 Console
502 10-tube.....	9027 Console
AC Super.....	7025 Console
022 12-tube.....	2225 Console
AC Super.....	2227 Console
	2228 Console
92 5-tube.....	925 Console

Thousands of Radio Men have asked for a book of this kind—

The RADIO-CRAFT INDEX

It contains a thorough, alphabetical and topical arrangement of EVERY article and subject which has been published in all the issues of RADIO-CRAFT from July, 1929 to June, 1932

RADIO Men have conclusively proved to us the need and practicability for a book which has included in it, a comprehensive and complete listing of every article which has thus far been published in RADIO-CRAFT. A book which has each topic so sub-divided and cross-indexed that a mere glance at a subject will give you any number of classifications and uses of it. For example, if you look at tubes, you find under this topic, various sub-titles, general, power, transmitting, photo-cells, testing of tubes, thyratrons, etc. Every article or notice in the book has been considered so deeply important that when you refer to a certain classification, listed below the main topic, you will find perhaps a dozen or more articles treating the subject from different angles. The author

in each case is given—the exact issue in which the article appeared, and on what page it is to be found. So accurately compiled, by C. W. Palmer, one of radio's foremost writers, that in less than two minutes you can turn to any article—needless to wade through all the issues of RADIO-CRAFT which have been published during the past three years. The RADIO-CRAFT INDEX is exactly the same size as the monthly magazine. It can be conveniently kept on file with the copies of the magazine—ready for quick reference. The index is printed on good paper with firm flexible covers to protect the inside. This book is sold only by the publishers at 25c the copy. Mail coupon below for your copy of the RADIO-CRAFT INDEX.

Briefly outlined below appears only a partial contents of the book

25c
the
Copy

THIS BOOK CANNOT BE BOUGHT ON THE NEWSSTAND—ONLY DIRECT FROM THE PUBLISHERS

Clip and Mail Coupon TODAY!

Publishers of RADIO-CRAFT, RC
96-98 Park Place, New York, N. Y.

Enclosed you will find my remittance of 25c (check, stamps or money order accepted) for which you are to send me, postage prepaid, one copy of the RADIO-CRAFT INDEX.

Name

Address

City..... State

<p>AMPLIFIERS— General Audio Frequency Intermediate Frequency Power Radio Frequency</p> <p>ANTENNA SYSTEMS— CABINETS— CIRCUITS— Commercial Experimental</p> <p>CODE— COILS AND TUNING— COMPONENTS— COOPERATIVE LABORATORY— DETECTORS AND RECTIFIERS— EDUCATION— INTERFERENCE AND HUM ELIMINATION— KINKS— MANUFACTURING— METERS AND TESTING EQUIPMENT— MISCELLANEOUS— MOTION PICTURE RECORDING AND PROJECTION— MUSICAL INSTRUMENTS— NEUTRALIZING— NOVELTIES—</p>	<p>PATENTS— PHONOGRAPH REPRODUCTION AND RECORDING— POWER SUPPLY AND BATTERIES— RECEPTION— General Airplane Automotive Broadcast D. X. Short-Wave</p> <p>REMOTE CONTROL— SELLING AND MONEY MAKING SERVICES— General Equipment Operating Notes Service Men's Data</p> <p>SET CONSTRUCTION— All-Wave Automotive Broadcast Short-Wave</p> <p>SPEAKERS AND REPRODUCERS— TELEVISION— General Reception Transmission</p>	<p>TOPE AND VOLUME CONTROL— TOOLS— TRANSFORMERS— General Audio Frequency Intermediate Frequency Power Radio Frequency</p> <p>TRANSMISSION— General Airplane Beam Broadcast Short-Wave</p> <p>TRANSMITTERS— General Airplane Amateur Broadcast</p> <p>TUBES— General Pentode Photo-cells Testing Thyratrons</p> <p>LIST OF BROADCAST, SHORT-WAVE AND TELEVISION STATIONS—</p>
--	--	---

ABSOLUTELY NOTHING WHICH HAS APPEARED IN RADIO-CRAFT HAS BEEN OMITTED FROM THIS VALUABLE COMPILATION

GREATEST MAGAZINE ON SHORT WAVES

NOW 25c A COPY



At All Large Newsstands

4-Color Cover
9"x12" in Size
Over 200 Illustrations

RAPIDLY increasing each day are the number of experiments in the Short-Wave field—developments which are bringing to this branch of radio thousands of new "thrill seekers." Experimenters, as in the early days of Radio, again have the opportunity to bring about stirring new inventions. Read in **SHORT WAVE CRAFT**, the **Experimenter's Magazine**, how you can build your own Short-Wave Set—both transmitters and receivers. **SHORT WAVE CRAFT** is exclusively a short-wave magazine—the kind you have wished for so long.

Interesting Articles in the Current Issue

- Insulation in Short Waves, by Hugo Gernsback.
- How the Sun Affects S-W Reception, by Dr. F. Noak.
- Short-Wave Thrills Galore on Two Tubes, by M. Harvey Gernsback.
- An A.C. Operated Short-Wave Converter, by R. B. Kingsbury.
- The "3-in-1 Monotube" Super-Regenerator, by R. William Tanner.
- Obtaining a License, by John L. Reinartz.
- W9ZG Saves A Life, by A. D. Middleton, W8UC. (short-wave fiction).
- A 20-Meter Transmitter, by A. Binneweg, Jr.
- A Super-Regenerator with Pentodes, by R. W. Tanner.
- Short-Wave Stations of the World (complete list).
- THE SHORT-WAVE BEGINNER, by C. W. Palmer.
- Taking the "Headaches" Out of CRYSTAL CONTROL, by George Shuart.

SPECIAL OFFER COUPON

SHORT-WAVE CRAFT RC-133
98 Park Place, New York, N. Y.

GET ACQUAINTED OFFER

As per your Special Offer, I enclose \$1.00 (Canada and foreign \$1.20) for which enter my subscription to **SHORT-WAVE CRAFT** for 8 months. (I understand that your regular rate for a year's subscription is \$2.50).

Mail me a sample copy of **SHORT WAVE CRAFT** for which I enclose 15c (U. S. Stamps or coin accepted).

Name

Address

City State

Battery Super.....926 Console
092 9-tube.....2925 Console
Battery Super.....
062 6-tube.....1622 Auto Radio
Auto Super.....Remote Control

WILCOX-GAY CORPORATION Trade Name: WILCOX-GAY

Designation of chassis	Designation of complete set	Alternative designation
2S5.....	2S5-30.....	Cameo
2T5.....	2T5-30.....	Cameo Hilo
2DB5.....	2DB5-32.....	Cantata
2EB5.....	2EB5-32.....	Cantata Hilo
2V7.....	2V7-31.....	Carillon
2V7.....	2V7-310.....	Coronet
2W10.....	2W10-515.....	Corona

ZENITH RADIO CORP.

Trade Name: ZENITH-ZENETTE

Designation of chassis	Designation of complete set	Alternative designation
7 tube 2022A.....	Models 210-220	
8 tube 2036A & B.....	Models 230-240-245	
9 tube 2031 Short & Standard Wave.....	Models 250-260-272	
10 tube 2030 } 0432 }	Models 410-411-420	
12 tube 2033.....	Models 210-5, 211-5, 270-5	

P.A. SYSTEMS

(Continued from page 403)

meet it, Chief Nichols has fitted up a small police booth with a three-stage amplifier and two horn speakers, the latter sticking through the peaked roof as shown in the accompanying illustration.

Motorists coming down the road are amazed to hear a loud, clear voice, telling them that "the Ford in the center of the road had better get over to the right," or "the red Buick with New Jersey plates better slow down." A hand microphone is attached to a long flexible cord, enabling the officer on duty to wander about and observe the flow of traffic from different vantage points. To say that this system is successful is putting it mildly. It is actually a sensation!

The low cost of the equipment and the ease of installation will unquestionably appeal to many other police departments, particularly in the hundreds of small cities and towns that do not need or cannot afford a short-wave radio alarm system. A similar stunt has been used with great effectiveness in Buffalo, N. Y., the amplifier and speaker in this case being located in a police automobile.

Service Men: show this picture to your local police chief and let him think the idea over. The fact that one city is already using the stunt will unquestionably make an impression on him.

Installation Problems

Because the loudspeakers and sometimes the amplifiers themselves are used outdoors and are therefore liable to damage by the elements, the question of service and maintenance in outdoor P.A. work is of paramount importance. Exposed horns should be tilted mouth downward to prevent rain and snow from accumulating. Dynamic speakers with baffles should be carefully boxed up or protected by false tops. Connecting wires must have thoroughly waterproof insulation, and all soldered joints must be made with rosin-core solder. The humid atmosphere around swimming pools—particularly salt water pools—raises the very devil with poor connections and unprotected surfaces.

If possible, install the amplifier, the microphone and the phonograph turntable in the manager's office, where it will not be tampered with. Encourage the manager himself to make announcements via the "mike." He'll probably soon learn to like his own voice, and you'll have a strong local booster for P.A. systems.

Free Service

Since the outdoor season is comparatively short, you can offer free service on your installation the first year without losing all your profit. This will undoubtedly appeal to the prospect, as he doesn't have to worry then about the apparatus, except for the little matter of paying for it.

Mayo REPLACEMENT PARTS

For All

Standard Receivers

SERVICE MEN know that replacement units for receivers must measure up to exactly the same standards in every respect as the original. Parts manufactured by MAYO are exactly made, constructed with materials of superior quality, and guaranteed for six months. MAYO Replacement Parts have been continually used by Service Men for many years—they fill every requirement.

MAYO Replacement Parts are made for use in over 100 standard radio receivers. The parts listed below are manufactured by MAYO.

Condensers	Chokes
Transformers	Coils
Resistances	Power Packs
Voltage Dividers	Microphones
Voltage Regulators	etc.
Filter Blocks	

Look for the MAYO signature on every replacement part—it marks your guarantee of the precision product.

Write today, address Dept. RC, for free booklet showing complete list of MAYO STANDARD REPLACEMENT PARTS.

MAYO LABORATORIES, Inc.
281 East 137th Street New York, N. Y.
Oldest and largest manufacturer of replacement units

More Capacity at Less Cost

LATEST research by oldest condenser manufacturer is reflected in present extensive and varied line of

DUBILIER ELECTROLYTICS

Available in all types—round and square metal cans, cardboard containers, tubular paper wrappings, high-voltage, low-voltage, tapped units, etc. Positively guaranteed for quickest reforming time, lowest leakage, highest working voltage, longest life. And they cost less!

WRITE for literature on Dubilier Electrolytics as well as all other types of condensers.

Dubilier Condenser Corporation
4377 Bronx Blvd. New York City

LYNCH ANTENNA SYSTEMS

\$5.00
List
Complete
Kit

More Profit
Lower Price
Easier to Sell
Easier to Install
Better Results

Eliminates Man-made static and permits the use of several receivers on a single antenna.

Special Offer: Dealers and Service organizations—A sample LYNCH "NO-STAT" will be sent at our special price of \$2.50. Clip this to your letterhead, enclose check or money order for \$2.50. After Jan. 15, 1933, the "NO-STAT" will be obtainable only through your jobber at regular discounts from \$5.00 list.

LYNCH MFG. CO., INC.
1775 Broadway, New York, N. Y.

P.A. SYSTEMS

(Continued from page 441)

matter of paying for it.

Typical Amplifier

A typical amplifier well suited for many different public address purposes is shown in the illustration. This is a 250 push-pull Loft-in-White job, employing a 57 direct-coupled to a pair of 50's, with two 81's acting as high voltage rectifiers. This amplifier is supplemented by a microphone amplifier stage using a single 56. Feeding two big RCA 106 dynamic loud speakers, this outfit will easily cover a crowd of 3,000 people. With a maximum output of 15 watts, it will handle a total of ten or eleven dynamics.

The dual output circuits have impedances of 400 and 2,000 ohms, adapting the amplifier for line transmission work as well as for high impedance speakers.

The compactness of this amplifier enables it to be put in the corner of an ordinary desk. It measures only 20 inches long, 11 1/2 inches wide and 8 inches high, overall, and is completely self contained in a strong steel chassis with all connections out of sight.

INFORMATION BUREAU

(Continued from page 424)

Such an arrangement is described by Mr. Nighswander in the December 1932 issue of RADIO-CRAFT, page 354. Since this description was published, an illustration of the set has become available and is reproduced as Fig. Q182B.

(Q. 3.) Why isn't it possible to take taps from the "B" portion of the power pack of radio set, and use this current to supply an external radio set, in lieu of the regular set, within the power output rating of the "B" unit?

(A. 3.) This idea of using the power supply of a radio set has been discussed in several past issues of RADIO-CRAFT. For instance the December, 1932 issue, "A Plate Circuit Adapter," page 377, Mr. Jack S. Stanton describes a unit for adapting the high-voltage supply of a receiver to the requirements of an external unit. A photograph of a unit built by Mr. Stanton is reproduced in Fig. Q.182C.

A 1-TUBE LOUDSPEAKER SET

(Continued from page 400)

circuit oscillation near the middle of the broadcast band. The required degeneration was obtained without difficulty, as the tickler coil was of the type which could be adjusted to either aid or oppose the signal.

Some difficulty was experienced at first in obtaining sufficient amplification at the higher wavelengths, but this fault was found to lie in the use of an R.F. choke having an incorrect inductance value for use as unit R.F.C.

The phonograph pickup connections of an external pickup may be connected to the input portion of the triode by connecting one lead to the blank binding post provided, and the other to the binding post marked "ANT." This provides a single stage of A.F. amplification and makes it convenient for anyone to enjoy phonograph music without disturbing other people. Most pickups are equipped with the variable resistor which is required to control the volume, otherwise, the tube will overload.

The Power Circuit

The most interesting part of the circuit is the arrangement of the power supply, which provides for practically every commercial frequency and voltage.

As the schematic circuit indicates, a bridge-connected dry-rectifier arrangement is used. There are several advantages to be gained by wiring the circuit in this manner. In the first place, it makes no difference which way the line-plug is plugged into the outlet plate, on D.C.; the results, in signal pickup, are almost identical with the plug connected in either direction. In the second place, the circuit shown makes it convenient to operate the set on either A.C. or D.C. without changing any wiring or components. Also, it makes no difference what the line frequency may be—the set will work with equal efficiency on 25, 40, 50 or 60 cycles, or on D.C.

By following the path which the current must follow in going through the bridge rectifier, it will be seen that regardless of the polarity of the current at the terminals of the line-plug, the output of the rectifier, which is

applied to the filter system, always remains at the same polarity.

By carefully center-tapping the power circuit for the filament of the tube, in the manner shown in the diagram, A.C. hum has been reduced to practically nothing. Through the use of a tube of the "auto-motive" or 6.3 V. filament type, line-voltage variations within rather wide limits have little effect on the operation of the set, which is designed for "110 V." supply. To work the set in locations where the supply is 220 V., it will be necessary to use a series resistor to reduce the line potential to the set to 110 V. An adapter unit is illustrated in Fig. 2B. A perforated bakelite tube may be arranged to contain the two 50 W. resistors, R, which have a value of 150 ohms each.

To protect the set against burnout, should it be accidentally connected to a 220 V. circuit (some hotels, for instance, supply their own current at this potential), without the adapter in circuit, two 3/4-A. fuses are connected into the line circuit. These fuses are contained inside the special line-plug specified in the List of Parts. It is cheaper to buy a couple of fuses, if need be, than it is to replace burned-out resistors and a tube. Don't forget to notch the side skirt of the chassis to provide an exit for the line cord.

A little trouble due to hum in the plate circuit was experienced until the filter system specified was worked out; the electrolytic condensers listed were used because of their small-space design. In fact, most of the equipment was selected with regard for size. There isn't much room to spare in this chassis.

Construction Details

Two 25 W. resistors, R2 and R3, reduce the line voltage to nearly the potential required by the filament of the tube; the remainder of the drop is obtained from the end sections of the 50 W. resistor, R4. This resistor is center-tapped; the section in shunt to the filament of the tube measures 100 ohms (there-
(Continued on page 443)

"Cliff" Denton

has written another valuable book for Radio Service Men

RESISTANCE MEASUREMENTS

The Modern Method of Servicing Radio Receivers

50c.

Of the difficult problems which Service Men face today when repairing receivers, the greatest is that of replacing proper resistance values in sets. This task becomes even more difficult when the values of resistors are unknown; and manufacturers of many standard sets do not pass this information on to Service Men.

In this new book, "RESISTANCE MEASUREMENTS," radio men will find the information needed to quickly place a receiver in normal operating condition. This book cuts in

half the time usually required to adjust the average set.

Sufficient space has been devoted to the elementary problems and the theory of electricity as it is applied to resistance measurements so that the Service Man will have a comprehensive idea as to how to overcome this problem.

Below you will find a partial list of the contents which will appear in this new book . . . prepared by one of radio's foremost service writers, Clifford E. Denton.

Partial Contents of RESISTANCE MEASUREMENTS

- CHAPTER 1—INTRODUCTION. Advantages of Resistance Measurement Method of Servicing for Radio Work.
- CHAPTER 2—Basic Principles.
- CHAPTER 3—Methods of Resistance Measurement.
- CHAPTER 4—Resistors in Radio Receivers and Amplifiers.
- CHAPTER 5—Point to Point Resistance Measurements in Typical Radio Set using Ohmmeter.
- CHAPTER 6—Resistance Measurements using Modern Tester.
- CHAPTER 7—Routine Testing where Circuit Diagram is Available and where Resistances are Known.
- CHAPTER 8—Routine Testing where Circuit Diagram is Not Available and where Resistances are Unknown.
- CHAPTER 9—The Relation of Voltage Testing Methods to Resistance Measurement.
- CHAPTER 10—APPENDIX. Resistance Charts, etc.

THIS BOOK IS A NEW
ADDITION TO THE
RADIO-CRAFT
LIBRARY SERIES.

GERNSBACK PUBLICATIONS, Inc. RC-133
96-98 Park Place, New York, N. Y.

Enclosed you will find my remittance of Fifty Cents (check, stamps or money order accepted), for which you are to send me One Copy of RESISTANCE MEASUREMENTS, by Denton.

Name

Address

City State

64 PAGES — OVER 100 ILLUSTRATIONS
FIRM FLEXIBLE COVERS—6x9 INCHES

CONSTRUCTING ADAPTERS

(Continued from page 409)

No. 975H, Fig. 94, is used with SG4600 and SG4700 to test the PZ, 33, 46, '47, LA and GA tubes.

No. 944R, Fig. 95, is an extension adapter with a reinforcement rubber ring to prevent the socket contact clips from breaking through continual use.

No. 945, Fig. 96, attaches to the test plug of SG4700 to change it to a 4-prong plug. In this case, however, the cathode is open.

No. 955R, Fig. 97. Same as No. 944R but made for 5-prong tubes.

No. 966R, Fig. 98, same as Nos. 944R and 955R except for 6-prong tubes. Used with the Statiktester.

No. 968, Fig. 38, changes a UX socket to a WD11 socket. Used with AC47, SG4600, SG4700 and the Statiktester.

No. 955PT, Fig. 99, is used with SG4600, SG4700 and the Statiktester for connecting meter in series with plate circuit.

No. 944JY, Fig. 13, is used with SG4700 to test the second-plate current of '80 tubes.

No. 944PTT, Fig. 100, is used with the Statiktester. Has external contacts for all elements of 4-prong tubes.

No. 955PTT, Fig. 101, same as No. 944PTT except that it is for 5-prong tubes.

No. 966PTT, Fig. 102, same as Nos. 944PTT and 955PTT except that it is for 6-prong tubes.

No. 944PT, Fig. 103, is used with models SG4600, SG4700, and the Statiktester having split plate connection for headphones or meter.

No. 972, Fig. 104, checks the Western Electric 215A in the UX 1.1-volt socket of any Hickok checker.

Na-Ald Adapters for Dayrad Testers

No. 955PO, Fig. 105, used with HR and 8-80 as output-meter adapter for pentode tubes. Connect AC meter and 1. mf. condenser in series with two leads from plate and plus filament.

No. 949, Fig. 106, is an output-meter adapter for UX tubes. Uses condenser and meter as described for 955PO.

No. 954DS, Fig. 107, changes the UY plug to a UX plug. Used with H-180, HR and 8-80.

No. 965KHGD, Fig. 108, checks the 55, 57 and 58 tubes in the Dayrad "L" checker with serial numbers 27450 and up.

No. 955KHH, Fig. 109, checks the 56 tube in the Dayrad "L" checkers with serial numbers 27450 and up.

Na-Ald Adapters for Readrite Equipment

No. 965DDT, Fig. 110, is used with Readrite models 15, 245, and 245A analyzers to enable analysis of 6-prong tube circuits to be made.

No. 975DDT, Fig. 111, is a twin adapter for use with Readrite models 15, 245, and 245A analyzers for the analysis of 7-prong tube circuits.

Miscellaneous Adapters

No. 973, Fig. 112, permits the testing of the 215A tubes in any set analyzer. Attach to test plug.

No. 944PLS used in connection with No. 944PLC to test the circuits of the 866 tube if set analyzer incorporates meter which will measure the current and voltage of this tube. See Figs. 113 for the No. 944PLS and 114 for the No. 944PLC.

No. 50UY, Fig. 115, is an adapter for testing 50-watt tubes. Attach to UY test plug.

No. UY50, Fig. 116, same as 50UY except that it fits the UY socket of tester.

No. 50UX, Fig. 117, is an adapter for testing 50-watt tubes. Attach to UX test plug.

No. UX50, Fig. 118, same as 50UX except it fits UX tester socket.

The writer has done considerable research work in getting together this list of adapters. We have tried carefully to eliminate errors. Errors are bound to creep into a work of this kind despite all efforts to keep them out. The writer will appreciate any reader of this magazine calling to his attention any errors which are noticed. By doing this, the reader will be helping others and will make it possible to keep this list up to date.

A 1-TUBE LOUDSPEAKER SET

(Continued from page 442)

fore, the two end sections measure 50 ohms each). A detail of the resistor-rectifier mounting is Fig. 2C. Holes in one end and the top of the aluminum chassis provide ventilation.

The antenna connects to the end of the primary of L1 which is furthest from the adjacent secondary; the far end of the secondary (adjacent to the tickler coil) connects to the control-grid cap of the tube. This tuner is made on a celluloid form 2 1/2 ins. in dia. The primary has 75 turns of wire (winding space, 1 1/8 ins.) spaced 1/8 in. from the secondary; secondary, 16 turns (winding space 9/32 ins.); tickler, 50 turns (winding space 2 5/32 ins.), 1 1/4 ins. in dia. Tap the secondary 20 turns from the grid end, by carefully pushing the turn inward and cleaning it for connection. Home-made R.F. transformers in lieu of R.F.T. are unsatisfactory as it is not possible to obtain the "R.F. iron" required for the core.

Any convenient antenna may be used. Do not use a ground!; resistors R2, R3, R4 take care of this. Touching a ground lead to the aluminum chassis will "blow the works." In rare instances it may be desirable to use an external ground, provided a 1 mf. condenser is connected in series with the ground lead. Be sure the antenna does not touch the ground. (Some experimenters prefer to connect a .1-mf. condenser in series with the antenna post and the primary of L1, as shown dotted, as a safety measure; a smaller capacity is not recommended as this condenser must also pass A.F. when a phono. pickup is connected into the circuit.)

An interesting variation of this circuit, as a short-wave receiver, is described in detail in the January, 1933, issue of SHORT WAVE CRAFT magazine.

List of Parts

One Hammarlund type MC-325M variable condenser, 320 mmf., C1;

One Gen-Win 3-Circuit Tuner, for 320 mmf. condenser, L1;

One Jefferson 5 to 1 type Star A.F. transformer, T;

One Dubilier Screen-Grid Duratran, R.F.T.;

One Micamold 500 mmf. fixed condenser, C2;

One Micamold .006-mf. fixed condenser, C3;

One Micamold 250 mmf. fixed condenser, C4;

One Aerovox 25 mf., 50 V. dry-electrolytic condenser, type PR50-25, C5;

Two Concourse type V-8, 8 mf. dry-electrolytic condensers, C6, C7;

One Lynch Metallized resistor, 2,500 ohms, 1 W., R1;

Two Electrad type B1 resistors, 100 ohms, 25 W., R2, R3;

One Electrad type C2 resistor, 200 ohms, 50 W., R4;

One Kenyon 30 hv. filter choke, type KC-350, Ch.;

One Sun I.F. choke, R.F.C.;

One Pair R. T. Co. type Express Featherweight headphones, 2,000 ohms.

One R.T. Co. S.P.D.T. toggle switch, Sw.;

One Littlefuse type 1037 fusible cap, P.;

Two Littlefuse 1/4-A. fuses;

One Pennsylvania type 85 tube, V;

One Na-ald 6-prong wafer socket for V;

One Wright-DeCoster bridge-connected dry-disc rectifier, type 217;

One Blan type KK knobs, for 1/4-in. shaft (one 1 in. in dia.; one, 1 1/2 ins. in dia.);

One Blan aluminum chassis, 6 1/2 x 11 1/2 x 1 1/2-in. thick;

One Blan aluminum strip, 3/8 x 1 1/2 x 1/8 in. thick (mounting for socket of V);

Two Blan aluminum strips, 2 1/4 x 1 1/2 x 1/8-in. (for rectifier-resistor unit);

One R. T. Co. twin-conductor No. 18 lamp-cord, 5 ft. long;

Two threaded brass rods, 4 1/2 ins. long, 8-32 thread;

One R. T. Co. carrying case, size 9 1/2 x 6 1/2 x 4 ins. (inside dimensions).

SERVICEMEN YOU NEED THIS!

Complete Kit of Parts for New METERLESS Tube Tester

This tube checker when built according to instructions will test 20 types of tubes, including the new 6-prong duplex Diode, Triode Tubes (Type 55).

Complete kit of parts for the Meterless Tube Tester, including drilled panel.

SPECIAL AT

\$5.00

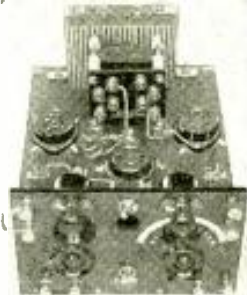

DeFOREST TUBES

Look at these prices—all perfect

400-A\$2.00	428	\$1.38	
401-A	439	1.38	
412-A	44555	
422	1.50	44575
424-A80	44788
42640	45180
42750	45663
43080	45780
43180	45880
432	1.15	471-A45
433	1.38	48050
43580	48253
436	1.38	568	3.95
43788	510 15w.	3.95
410-81	1.95	508-A-11-45	14.45
450	2.50			

6 MF.—600 VOLT FILTER BLOCK

This neat unit contains 1-4 mf. and 1-2 mf. filter section, both at 600 volts D.C. working voltage. Put up in a neat metal shield can, provided with mounting flange and convenient soldering lugs. Excellent for replacement and constructional work. May also be had with wire leads for Sub-panel Mounting. Measures 5" high x 2 1/2" wide x 3 1/4" deep ... **\$1.10**

KENYON REPLACEMENT POWER TRANSFORMERS

Provided with universal mounting brackets and convenient soldering lugs, properly identified. 3 types available:
Type KR-1. High voltage, 700 volts, etc., 125 MA; 5 volts, 2 amp; 2 1/2 volts, etc., 3 amp; 2 1/2 volts, etc., 10 1/2 amp. **\$3.15**
Type KR-2. High voltage, 580 volts, etc., 85 MA; 5 volts, 2 amp.; 1 1/2 volts, etc., 4.2 amp. **\$2.40**
Type KR-3. High voltage, 650 volts, etc., 60 MA; 5 volts, 2 amp.; 2.5 volts, etc., 2.5 amp. **\$2.40**

THORDARSON PLATE TRANSFORMER Type B.H.

This transformer may be used as a replacement in receivers where the high voltage winding has become shorted or burnt-up. Merely leave the old transformer there, mount the new one, and you're all set to operate once more. Comprises center tapped high-voltage winding of 285 volts, either side of CT, and tapped primary to accommodate line voltages from 95 to 115 volts. Excellent replacement transformer for Majestic Super B and other B Eliminators using Rathorn tube. Electrostatically shield. **\$1.25**
Ship. wt., 4 lbs. List Price, \$8.00

R.C.A. 30 HENRY CHOKE

Genuine RCA 30 Henry Choke, capable of passing 125 ma without heating. D.C. resistance 200 ohms. For replacements in all RCA-Victor receivers as well as for constructional and experimental work. May be used in all types of filter circuits for P. A. systems, amplifiers, radio receivers, etc. Measures 3 1/2" high x 3" wide x 2 1/4" deep. Sold in original factory containers. **79c**
Ship. wt., 4 lbs.

Mail Orders Filled Same Day. 10% cash must accompany all C. O. D. Orders.

LEEDS

The Home of RADIO

45D Vesey Street New York, N. Y.

The Radio-Craft Library is now complete!

Presented on this page are the new books of the RADIO-CRAFT LIBRARY—the most complete and authentic set of volumes treating individually, important divisions of radio. Each book has been designed to give radio men the opportunity to specialize in one or more of the popular branches of the industry. The material con-

tained in these books will increase your knowledge; you will find them a real help in your work and they will contribute to your money earning capacity. Read these books during your spare time at home.

The authors of these books are well-known to everybody. Each one is an expert radio man; an authority on the

subject—each is thoroughly familiar with the field which he represents.

This is perhaps the first real opportunity that you have ever had to build a radio library of books that are authentic, right-up-to-the-minute and written so that they are easily digested and clearly understood. Mail coupon below for your books.

TO THE RIGHT WILL BE FOUND A SHORT RESUMÉ OF EACH BOOK



Book No. 1

RADIO SET ANALYZERS

And How to Use Them

With Full Instructions and Descriptions of Set Analyzers, Tube Checkers, Oscillators, Etc.

By L. VAN DER MEL

This book explains thoroughly the operation of set analyzers, tube checkers, oscillators and other testing equipment. For every radio man this book is extremely helpful. It covers every phase of testing and gives you valuable short cuts; completely illustrated with photographs and diagrams to facilitate the use of modern testers.

Book No. 2

MODERN VACUUM TUBES

And How They Work

With complete Technical Data on All Standard and Many Special Tubes

By ROBERT HERTZBERG

MODERN VACUUM TUBES describes the fundamental electron theory which is the basis of all vacuum tube operation, and goes progressively from the simplest two-element tubes right up to the latest pentodes and thyatrons. It is written in clear, simple language and is devoid of the mathematics which is usually so confusing. Valuable reference charts and characteristic curves of standard and special tubes are to be found, also diagrams of sockets and pin connections.

Book No. 3

THE SUPERHETERODYNE BOOK

All About Superheterodynes

How They Work, How to Build and How to Service Them

By CLYDE FITCH

There is no more fascinating a subject in the large array of radio circuits than the famous superheterodyne circuit. Whether you are a Service Man or experimenter, first-hand knowledge about the construction of superheterodyne receivers is very important. The book on Superheterodynes gives underlying principles of their construction, right from the very first set made.

Book No. 4

MODERN RADIO HOOK-UPS

The Best Radio Circuits

A Complete Compendium of the Most Important Experimental and Custombuilt Receivers

By R. D. WASHBURNE

It is fascinating to the experimenter, or even to the up-to-date Service Man, to take a commercial set and to change it into one using a famous hookup that is not found in any manufactured set. Many excellent circuits have never been commercialized, but limited only to homeset builders. Thousands of these popular circuits have been re-created from time to time, and in this book we have included over 150 circuits, which include the famous Perdyne, Cash-Box A.C.-D.C. Set and others.

Book No. 5

HOW TO BECOME A RADIO SERVICE MAN

How to Get Started and How to Make Money in Radio Servicing

By LOUIS MARTIN

The ambition of many men in radio today is to become a first-grade Service Man. It is not as difficult as one might believe, but it cannot be done in a few short months. Following very carefully the advice of Mr. Martin, who has dealt with the problems of thousands of Service Men, this book deals very carefully with the essential stages in the preparation for qualifying as a Service Man.

Book No. 6

BRINGING ELECTRIC SETS UP TO DATE

With Pentodes, Multi-Mus, Dynamic Speakers—Complete Information How to Modernize A. C., D. C. and Battery Operated Receivers

By CLIFFORD E. DENTON

In this country there are over ten million electrically operated receivers that could be modernized—by placing in them new type tubes, new speaker equipment and other modern improvements. This business of improving old sets can go to the experimenters and Service Men if they will quickly jump into action.

Read in this book by Mr. Denton, how easily you can modernize any obsolete set, and with little additional costs.

Book No. 7

RADIO KINKS AND WRINKLES

For Service Men and Experimenters

A Complete Compendium on the Latest Radio Short-Cuts and Money-Savers

By C. W. PALMER

It often becomes necessary for experimenters and Service Men to call upon their memory for some short cut or radio wrinkle that will solve a problem quickly. In business, "short cuts" mean time and money saved, and to the Service Man "time saved" means money earned.

This book is a compilation of important radio kinks and wrinkles and discusses only such items as are constantly used today.

Book No. 8

RADIO QUESTIONS AND ANSWERS

A Selection of the Most Important of 5,000 Questions Submitted by Radio Men During the Course of One Year

By R. D. WASHBURNE

There have been collected a wide variety of questions which have come into our editorial offices during the past two years, and only those whose answers would benefit the majority of men engaged in radio have been incorporated in this amazing question and answer book. A tremendously long list of topics is treated.

Book No. 9

AUTOMOBILE RADIO AND SERVICING

A Complete Treatise on the Subject Covering All Phases from Installing to Servicing and Maintenance

By LOUIS MARTIN

Automobile radios are up and coming, and someone has to service them properly. It therefore behooves you to read this immensely important new book on the art of Automobile Radio. The book is concise, and full of illustrations, photographs, diagrams and hookups.

A few of the really interesting chapters: Introduction; Automotive Radio Installations; Complete Descriptions of Commercial Automotive Receivers; Servicing Automotive Receivers; The Ignition System; General Service Considerations; Effects of Temperature on Power Supply; Conclusion.

Book No. 10

HOME RECORDING AND ALL ABOUT IT

A Complete Treatise on Instantaneous Recordings, Microphones, Recorders, Amplifiers, Commercial Machines, Servicing, etc.

By GEORGE J. SALIBA

If there is one subject that is fascinating to every radio man, it is that of Home Recording. Of course, this volume is not all on "Home" recording, but the information contained therein is important to commercial radio men, studio operators, engineers and others interested in this phase of radio.

The art of recording and reproducing broadcast selections is becoming more important every day to radio men, experimenters and Service Men. Equipping dance halls, auditoriums, churches, restaurants and homes with public address systems and amplifiers brings many extra dollars and often an excellent income.

BIG DISCOUNT OFFERED

In order to make it possible for everyone to buy these books, the fifty (50) cent price has been made uniform for all volumes. You can buy these books separately, but you should take advantage of our special offer:

When Five (5) Books or More are Ordered Deduct 20% from Your Remittance

Simply fill in the coupon below, and mail it to us together with your remittance. Checks, stamps or money orders accepted.

ALL BOOKS UNIFORM

The books in the new RADIO-CRAFT LIBRARY are all strictly up-to-date, and written by men who know their subjects. The volumes are all uniform size, 6x9 inches, and contain on an average of 50 to 120 illustrations. Each book is printed on fine book paper, and no expense has been spared to make it an outstanding value, for its editorial contents as well as from the mechanical standpoint.

Clip Coupon and Mail Today!

GERNSBACK PUBLICATIONS, INC., 96-98 Park Place, New York, N. Y.

I have circled below the numbers of books in the RADIO-CRAFT LIBRARY, which you are to send me, and have deducted 20% for ordering five (5) books or more. I have included my remittance in full, at the price of 50c each, when less than five books are ordered.

The amount of my remittance is.....(Stamps, checks or money orders accepted.)
Circle numbers wanted: 1 2 3 4 5 6 7 8 9 10

Name Address

City State HC-1-33



An Amazing Buy!

The name

STROMBERG-CARLSON

assures you of getting only the finest in radio.

Stromberg-Carlson

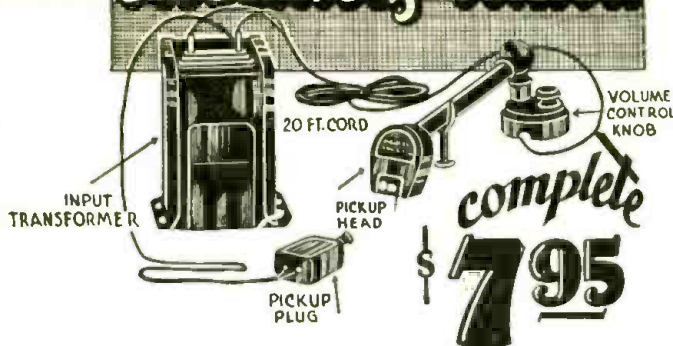

Exceptional Value!

As fine a pickup as has ever been made. This is being offered to you at an unusually low price.

There is nothing finer than a Stromberg-Carlson

Here is a phonograph pickup that will meet the requirements of the most discriminating. Made by a firm that is well known for high quality and well designed instruments. The tone arm is balanced for light needle pressure. A well designed input transformer, 20 foot cord, pickup plug and

volume control complete the assembly. Tone quality unsurpassed. Thousands in use in the best installations. This pickup can be used for home recording due to its low impedance. (200 ohms).

R. C. A. Magnetic Speaker Chassis

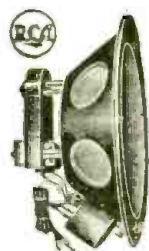

This chassis is the identical one used in the R.C.A. Model 100A and 100B Speakers, WHICH LIST FOR AS HIGH AS \$35.00. Note built-in OUTPUT TRANSFORMER—permits use of 450 volts, without distortion, rattling or blasting. **GENEROUS OVER-SIZED MAGNETS.** The thick armature is ACCURATELY CENTERED. The **STURDY METAL FRAME IS LINED WITH A SPECIAL SELF-BAFFLING FABRIC**, greatly improving acoustic properties of this sensational speaker! **NOTE THE CORRUGATED SURFACE OF THE CONE. AN EXCLUSIVE FEATURE—ENHANCES PERFECT TONAL REPRODUCTION QUALITIES CONSIDERABLY: MOST COMPACTLY MADE: 9 inches OUTSIDE DIAMETER, 4 1/2 INCHES DEEP OVER ALL.** **Your Price \$3.25**

CONDENSER

POWERTONE

Battery Operated Short Wave Receiver

TWO VOLT TUBES

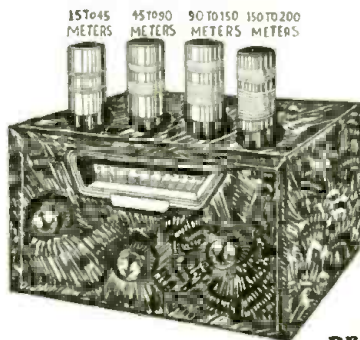

HAMMARLUND

—15 TO 200 METERS

YES, stronger than ever, so do we voice our and countless other opinions on this remarkable shortwave battery operated receiver. Faster than ever in sales volume, for the public has caught up with us in voicing their enthusiasm on results with this receiver. Never before has reception such as this been available on any two or three tube battery operated shortwave set.

The use of the new two volt, air cell, tubes increase reception sensitivity, and selectivity, furthermore, current consumption is kept at a minimum. Provisions are made within the receiver to reduce three volts so that dry cells can be utilized.

The set itself is made up of the best parts available including a Hammarlund condenser for tuning purposes. The parts are sturdily mounted on a metal base, which in turn is placed into a beautiful crackle finished metal cabinet to completely shield its entire contents.

A set of four plug-in coils is furnished with the receiver and cover from 14 to 200 meters.

Truly does this set earn the statement "Round the World Reception."

Set of batteries, \$2.25

Set of R. C. A. licensed tubes, \$2.50

\$9.95 WITH COILS

Victor Hand Microphone

Used with Victor R. E.-57 and R.C.A. 86 Home Recording Combinations



A single-button Microphone fine for home recording and amateur broadcasting. 100 ohm button. Operates on a 1 1/2 v. dry cell and draws 10 mils. Gun metal finish, equipped with 5 ft. cord.

Your Price \$2.45

PRIME A. C. MOTOR

For 110 Volts 50-60 cycle A. C.

A sturdy powerful compact heavy duty motor of the self-starting induction type. Will not set up disturbing noises in any receiver. Equipped with large bearing surfaces to provide adequate support and to insure long life. Quick starting, full speed is attained instantly. Comes ready to mount with turntable, mounting plate, on-off switch and speed control.

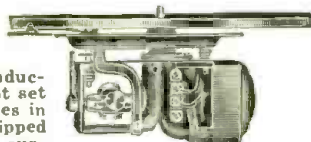

Our Price \$5.50

FARRAND INDUCTOR DYNAMICS

Used on A.C., D.C., and Battery Sets with Equal Results.

9" Model

\$5.95

12" Model

\$6.95



MP D. C. MOTOR

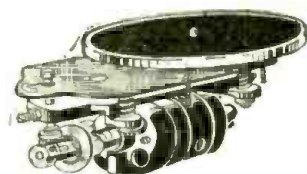

These motors are absolutely noiseless. Built as only motor manufacturers could know how, they are an epitome of phonograph manufacture. The ideal motor to use for recording. They have ample power to operate any recorder head. Completely equipped with speed regulator, cord and attachment plug, and a 12" turntable to take any size record.

Your Price \$7.95

BANQUET MIKE STAND

Extends from 18 to 30 inches. The ring will fit any standard size microphone. Due to a limited supply we advise you to get one at this low price.

Your Price \$3.50



All offers are F. O. B. New York, and subject to prior sale. Terms: A deposit of 20% is required with every order. Balance may be paid on delivery. Or, deduct 2% if full amount is sent with order.

GRENPARK CO.,

Dept. R. C.

245 GREENWICH STREET, NEW YORK, N. Y.

SEND NO MONEY--

Clip and mail to us the coupon below. We will send you either one or both books through the Express Company for your inspection. You have the privilege of keeping or returning them.

With these Radio Manuals in your files you can always have on hand a complete set of all Radio diagrams



Volume I, 1931 Edition

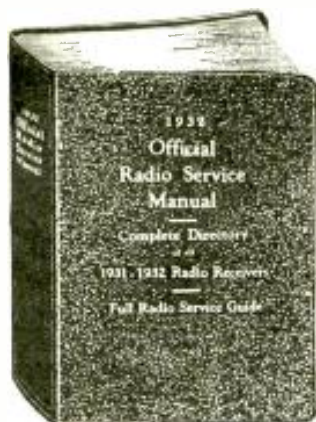

Volume II, 1932 Edition

These two volumes of the OFFICIAL RADIO SERVICE MANUAL give you a most complete set of circuit diagrams ever published for the Radio Industry. Every Radio Service Man and Dealer should have them available for immediate use in his business. Professional set-builders and amateurs will find them instructive and helpful.

Briefly outlined below are the "high spots" that are to be found in the 1931 Manual—the first complete radio service manual ever to be published. Over twenty-seven thousand copies of this edition were sold to members of the radio industry. This assures you of its importance to those engaged in radio and how valuable it is to them.

Partial Contents

Wiring diagrams of radio sets manufactured since 1927, and many earlier ones of which there is no record elsewhere.

650 pages of radio-servicing material.

Complete course on servicing for Radio Service Men, dealers, manufacturers, jobbers, set builders and amateurs.

(Here are but a few of the subjects covered in the special course of instruction.)

Amplifiers	Power-Supply Systems
Antennae	Radio Phonograph
Automotive Radio	Equipment
Condensers	Resistors
Detectors	Short-Wave Sets
Eliminators	Speakers
Meters	Tubes

\$4.50 Complete with Supplements

650 PAGES

(Complete with Supplements)

Over 1,500 Diagrams, Charts and Illustrations

Get Supplements FREE with the NEW 1932 MANUAL

There is so much new material in this Manual, that a Service Man or dealer would be lost without it when called to service a set. Information about new models which have been on the market only a short time are contained in this book. The 1932 Manual makes the service kit complete.

The 1932 Manual contains a Full Radio Service Guide and a Complete Directory of all 1931-1932 Radio Diagrams, also models of older design. Everyone in the Radio business should have a copy. Send for yours today!

Partial Contents of Volume II

A step-by-step analysis in servicing a receiver which embodies in its design every possible combination of modern radio practice; it is fully illustrated and thoroughly explained. It is the greatest contribution to the radio service field.

Chart showing the operation of all types of vacuum tubes, whether new, old or obsolete. An exclusive resume of the uses of the Pentode and Variable-Mu Tubes and their characteristics.

Complete discussion of the superheterodyne and its inherent peculiarities. Also a special chapter on tools used on superheterodyne circuits. Schematic diagrams and circuits complete with color codings.

Important chapters on commercial aircraft radio equipment; new data on commercial short-wave receivers and converters.

Servicing and installation of public address systems and talking machine equipment.

Standardized color-codings for resistors.

Operation of old and new testing equipment; tube volt-meters, output meters, oscillators and aligning tools.

A full section on Midget radios—their design, circuits, and types. How to service them most economically.

Hundreds of schematic diagrams of older radio receivers which have never been published.

Blank pages for recording notes, diagrams and sketches; these pages are transferable to any part of the book.

COUPON PAGE FOR FREE QUESTIONS AND ANSWERS.

\$5.00 Complete with Supplements

OVER 1,000 PAGES

(Including Supplements)

Over 2,000 Diagrams, Charts and Illustrations

Flexible, Looseleaf Binder, 9 x 12 inches.

CLIP COUPON AND MAIL TODAY!

GERNSBACK PUBLICATIONS, Inc. RC-1-33
96-98 Park Place, New York, N. Y.

Please send me for FREE inspection, the books I have checked below. I understand I may examine them carefully, and should I decide to keep them, I will pay the full cost, plus the few cents for carrying charges. This offer is good only in the U.S.A.

- Volume I, 1931 Manual, with Supplement, \$4.50.
 Volume II, 1932 Manual, with Supplements to be mailed Free every 60 days, \$5.00
 BOTH BOOKS FOR \$9.00.

Name _____

Address _____

City _____ State _____

Flexible

Looseleaf

Binder,

9 x 12 inches.

NOT ONE OF THE DIAGRAMS PUBLISHED IN VOLUME NUMBER I OF THE OFFICIAL RADIO SERVICE MANUAL IS REPEATED IN VOLUME NUMBER II.

HERE'S THE GUARANTEE

that built the largest institution of its kind in the world of

RADIO!

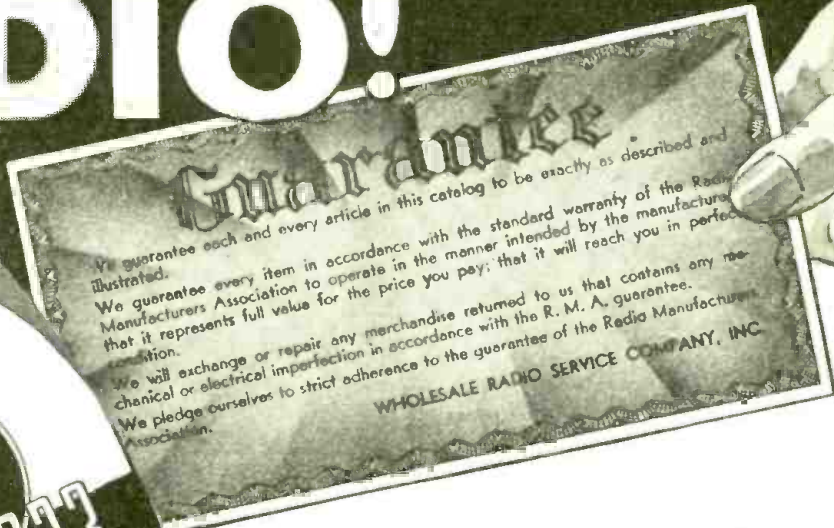

NO RADIO SERVICE IS GREATER THAN THE COMPANY BEHIND IT!

This NEW Catalog
SENT FREE!

We invite you to write for a FREE copy of the new 1933 WHOLESALE RADIO catalog—bargain book of the radio industry. Anything and everything in radio—no matter how big or small. A complete line of LAFAYETTE RECEIVERS, short-wave, long-wave and broadcast models, in a splendid selection of mantel and console cabinets. TRUATEST PARTS of super-fine quality—and a COMPLETE LINE OF REPLACEMENT PARTS FOR EVERY SET.

Mail the coupon today. It will bring you, without charge, the new 1933 WHOLESALE RADIO CATALOG.

Featuring an especially fine line of PUBLIC ADDRESS SYSTEMS and AMPLIFIERS—which offer an exceptional opportunity to capitalize on the tremendous current interest in PUBLIC ADDRESS.

WHOLESALE RADIO SERVICE COMPANY, the oldest, largest institution of its kind in the world, has been established in the radio field for over 11 years. Thousands of radio service men and dealers all over the world keep in touch with the newest developments in radio through the medium of our catalog. Everything we sell—radio sets, tubes, speakers, kits, accessories public address systems, amplifiers, replacement parts, etc.—is backed by the nationally known WHOLESALE RADIO SERVICE COMPANY GUARANTEE—a guarantee that means what it says—that is your protection and assurance of 100% satisfactory dealings. We guarantee to please you—to give you what you order—we never substitute. Furthermore we guarantee our merchandise to be absolutely as represented—free from defects. Our prices are always consistently low—they meet and beat competition. Our customers reap the benefit of current price reduction made in the field—prices are reduced and refunds made whenever any prices are lowered—even though our catalog price is already printed). And—since no guarantee is worth more than the company behind it—WHOLESALE RADIO SERVICE COMPANY offers you the additional protection of a large, well established, financially strong organization, with tremendous resources. We invite you to look us up—investigate our reputation and credit standing—find out for yourself why our slogan "THE RELIABLE HOUSE OF RADIO" means honest dollar for dollar value and the quickest, fastest service in the radio field.

Mail Coupon TODAY

WHOLESALE RADIO SERVICE CO.,
100 Sixth Ave., Dept. C-13,
New York, N. Y.

I shall be glad to receive a FREE copy of your new 1933 radio catalog. Please mail it immediately.

Name.....

Address.....

Town..... State.....

WHOLESALE RADIO SERVICE CO., INC.
100 SIXTH AVE. NEW YORK

They Have Copied Everything—

Except **CERTIFIED TRIAD Quality**

IT IS WRITTEN—

“Imitation is the sincerest form of flattery”

TRIAD

Appreciates the compliment it receives each month from other tube manufacturers who have copied our sales plan—our method of advertising—our discount schedules

TRIAD

Was first to recognize the Service Man

TRIAD

Was first to make double-tested tubes

TRIAD

Was first to offer a plan which really makes money for the dealer and Service Man

OTHERS

have made every effort to do the same thing

BUT

THEY HAVE NOT BEEN ABLE TO DUPLICATE

CERTIFIED

TRIAD → Quality

TUBES

A NEW DEAL

Some of our Service Men and Dealers have wanted to buy regular Triad Tubes to meet ordinary competition—

We have worked out a special proposition with most attractive discounts, and will be glad to supply the details upon request.

With regular Triads and Certified Triads you can beat any kind of competition.

CERTIFIED Triad Dealers and Service Men everywhere have sold many thousands of these tubes,—they are making money—there hasn't been a single complaint. Mail the coupon today and learn how you can sell these super-grade tubes at a real profit. We protect you in your territory and you are sure of all of the inducements offered by other manufacturers, plus quality which is in a class by itself. **GET THE FACTS!**

TRIAD Manufacturing Co.
Pawtucket, R. I.

Gentlemen:

Please send me the outline of the CERTIFIED TRIAD Sales Plan for Dealers and Service Men.

Name.....

Address.....

City.....State.....

My letterhead or business card is attached



SM

SILVER - MARSHALL

are pleased to announce the
opening of

New Executive and Sales Offices

at

189 West Madison Street
(In the Loop)

Chicago, U. S. A.

All correspondence should be addressed to this office

Write for complete technical information, also
prices and proof of performance on the new CB-1.
A custom-built receiver that surpasses on every
count all claims ever made on any previous radio.

SILVER-MARSHALL, Inc.